

BALUNS AND FERRITES

Jacques Audet
VE2AZX

VE2AZX@amsat.org

- REASONS FOR USING A BALUN
- TYPES OF BALUNS
- CHECK YOUR BALUN WITH AN SWR ANALYZER
- MEASURING THE IMPEDANCE OF A NUMBER OF FERRITES
- IMPEDANCE MEASUREMENT RESULTS
- USING FERRITES ON A FEEDER AND HOUSE CONDUCTORS

REASONS FOR USING A BALUN ?

BALUN = BALanced to Unbalanced - It's a transformer

Used to feed a balanced load, Ex: dipole

Decreases feeder radiation

The feed line becomes independent of the antenna:

We can change its length ... move it around

Without causing SWR change.

REASONS FOR USING A BALUN ?

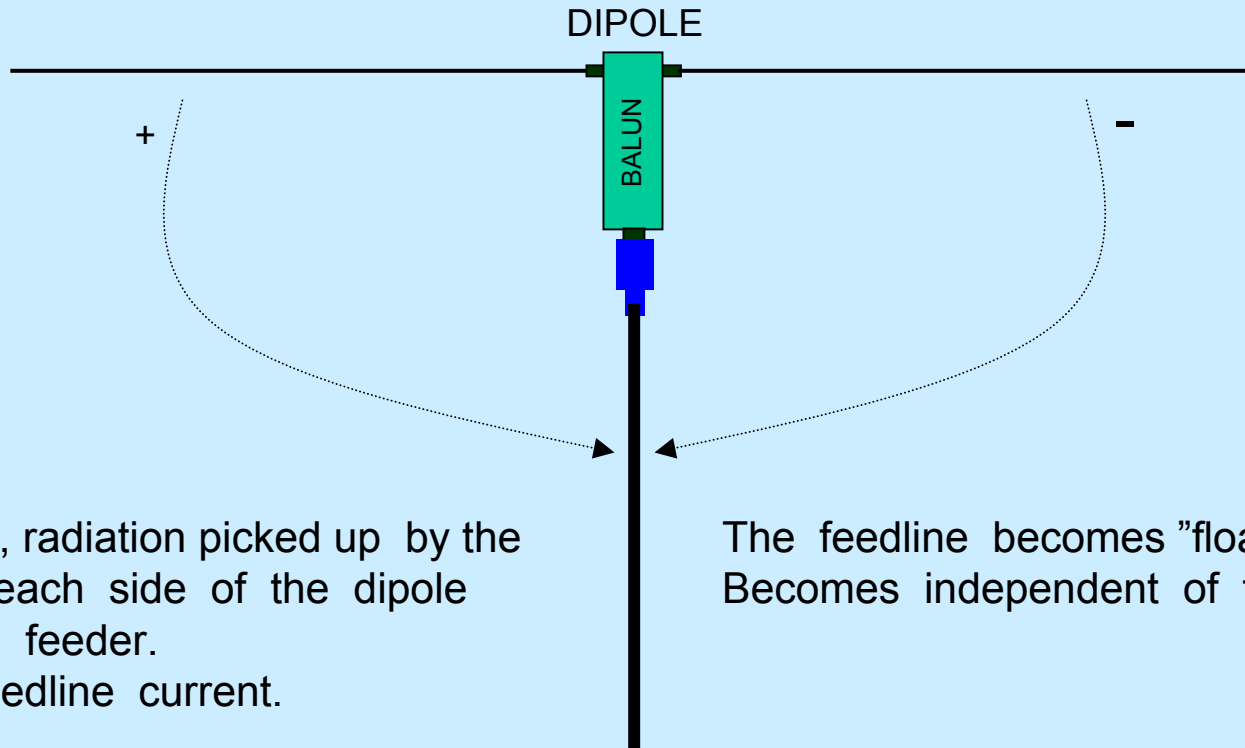

With a balun, radiation picked up by the feeder from each side of the dipole cancels at the feeder.
Decreases feedline current.

The feedline becomes "floating" and
Becomes independent of the antenna.

The feedline should run away from the dipole at right angle.
The dipole should be parallel to the ground.

A non symmetrical antenna Ex: Windom...
Will require the use of a current balun

TYPES DE BALUN

VOLTAGE

- TRANSFORMER WITH WINDINGS GIVING A BALANCED OUTPUT
- IN-OUT IMPEDANCES ARE DETERMINED BY THE TURNS RATIO. A WIDE RANGE OF RATIOS IS POSSIBLE.
- OPERATES OVER A SOMEWHAT LIMITED BANDWIDTH (100 TO 1)

CURRENT

- USES TRANSMISSION LINES WOUND ON A CORE
- MAY USE A COAXIAL CABLE OR A PARALLEL WIRE LINE WITH OR WITHOUT FERRITES.
- COMMON IMPEDANCE RATIOS: 1:1 AND 4:1
- OPERATE OVER A MUCH WIDER BAND OF FREQUENCIES

1:1 VOLTAGE BALUN

- 3 IDENTICAL WINDINGS

- GENERALLY 50 : 50 ohms

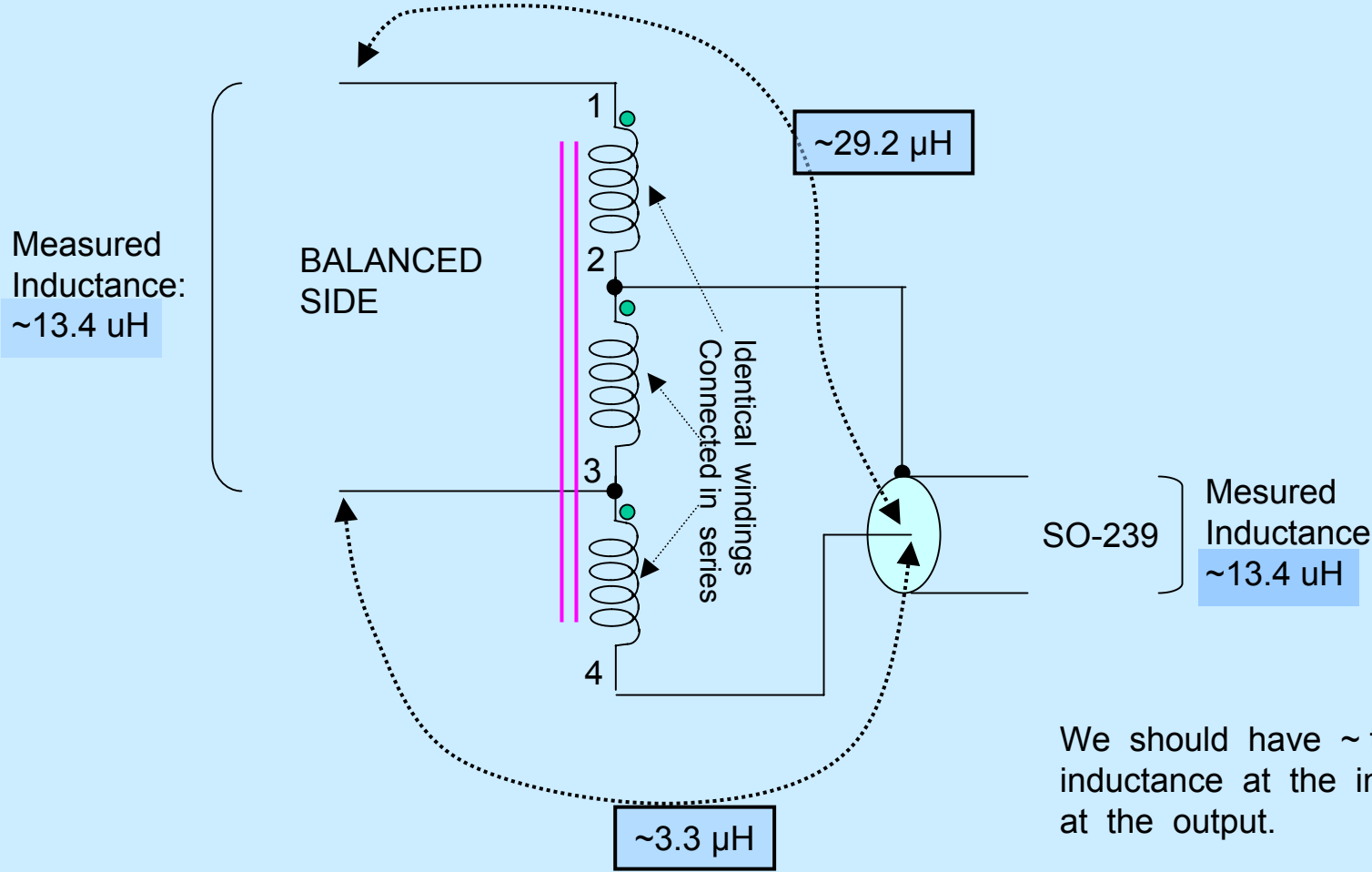

We should have ~ the same inductance at the input and at the output.

VOLTAGE BALUN 4:1

- 2 IDENTICAL WINDINGS

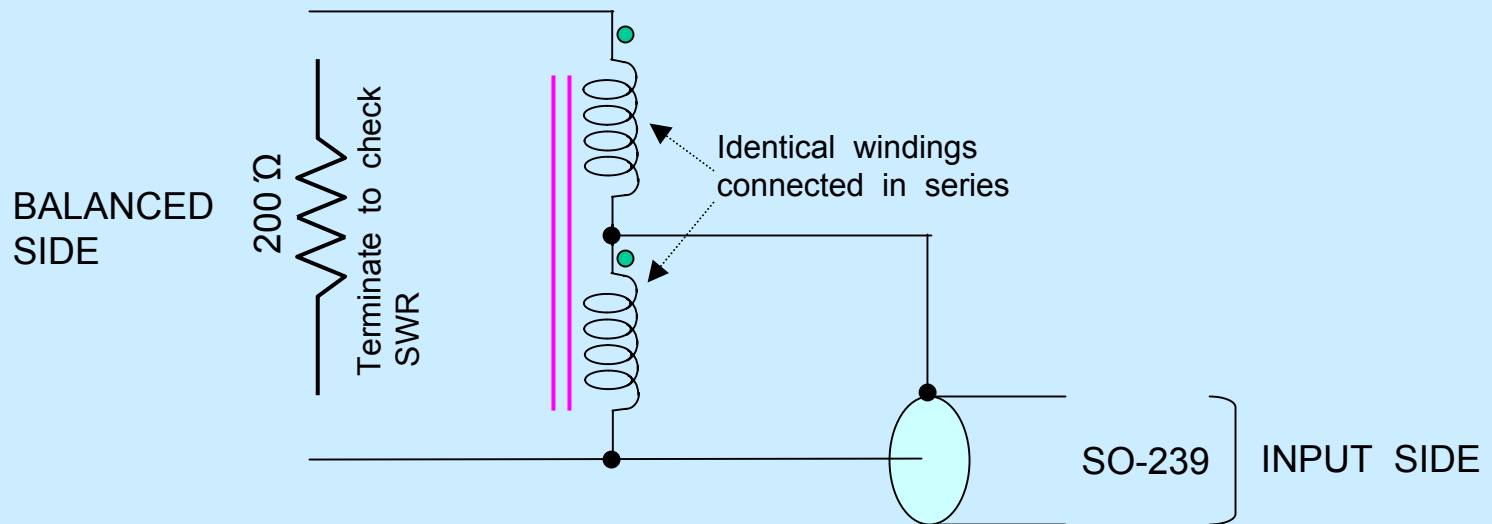

The measured inductance at the output is ~ 4X the input inductance as a result of inductance coupling.

TESTING A BALUN WITH AN SWR ANALYZER

These tests verify:

- Winding inductance
- Winding distributed capacitance

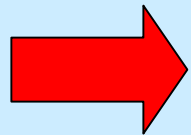
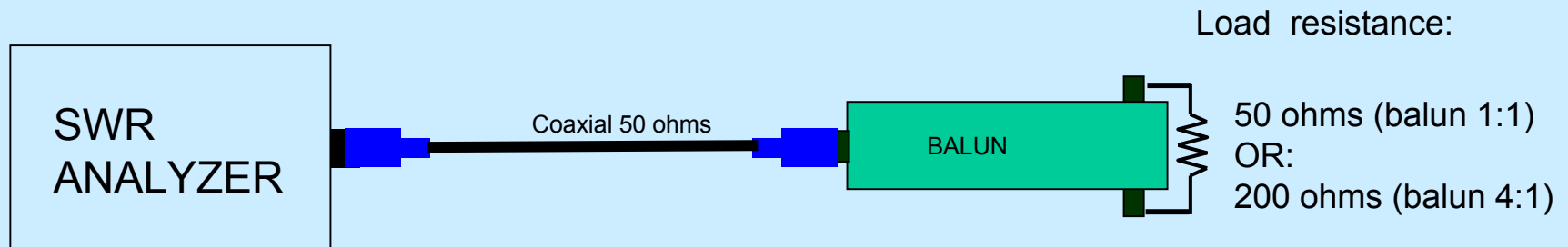

The minimum SWR should be below 1.5
In the middle of the balun's frequency range

Indicates low losses

CONNECTING THE LOAD RESISTANCE 50 Ω HERE

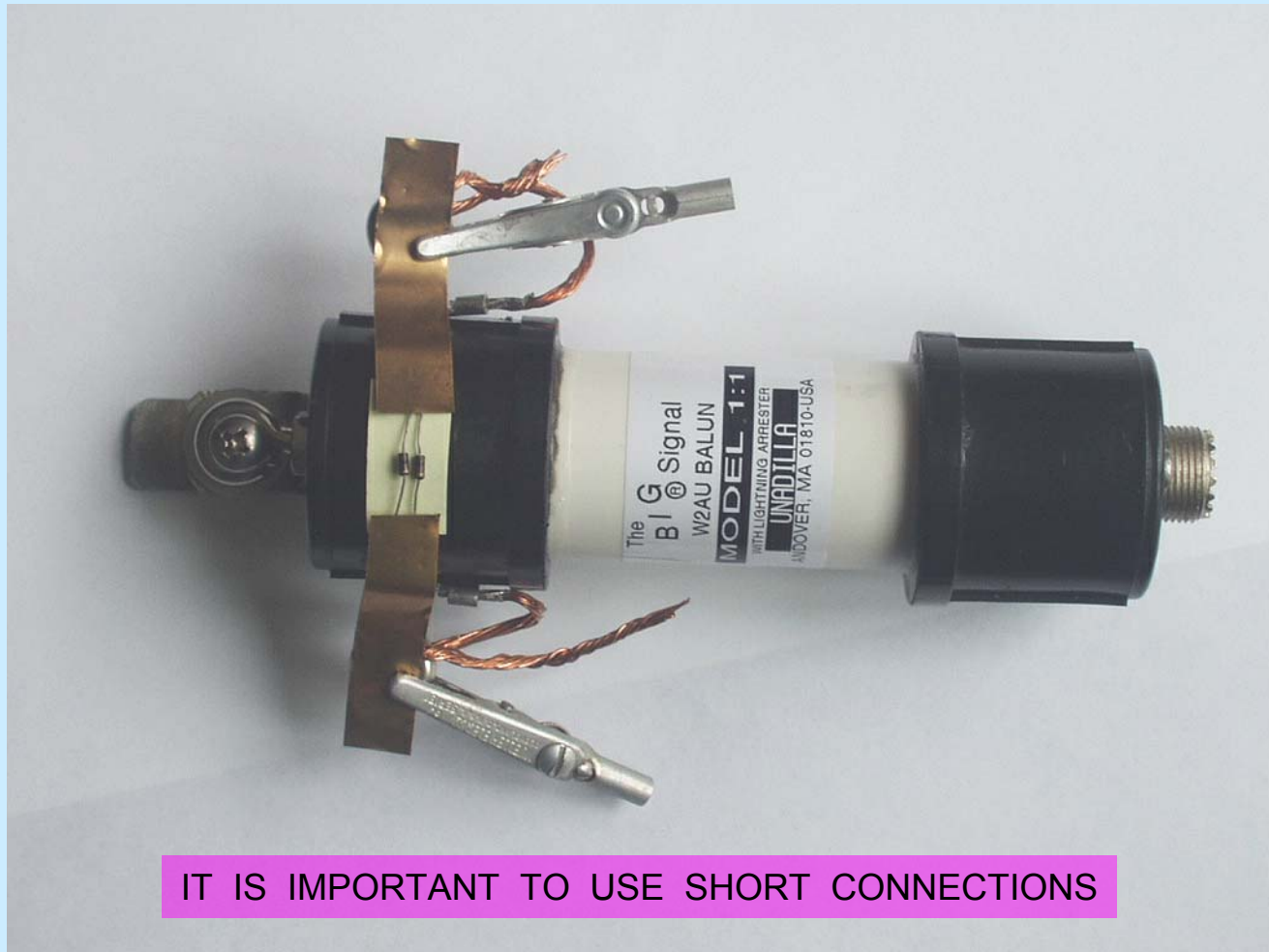

CH1 S11 SWR 100 m / REF 1

1: 1.4318 ← SWR

MEASURED SWR WITH A 50 ohms LOAD

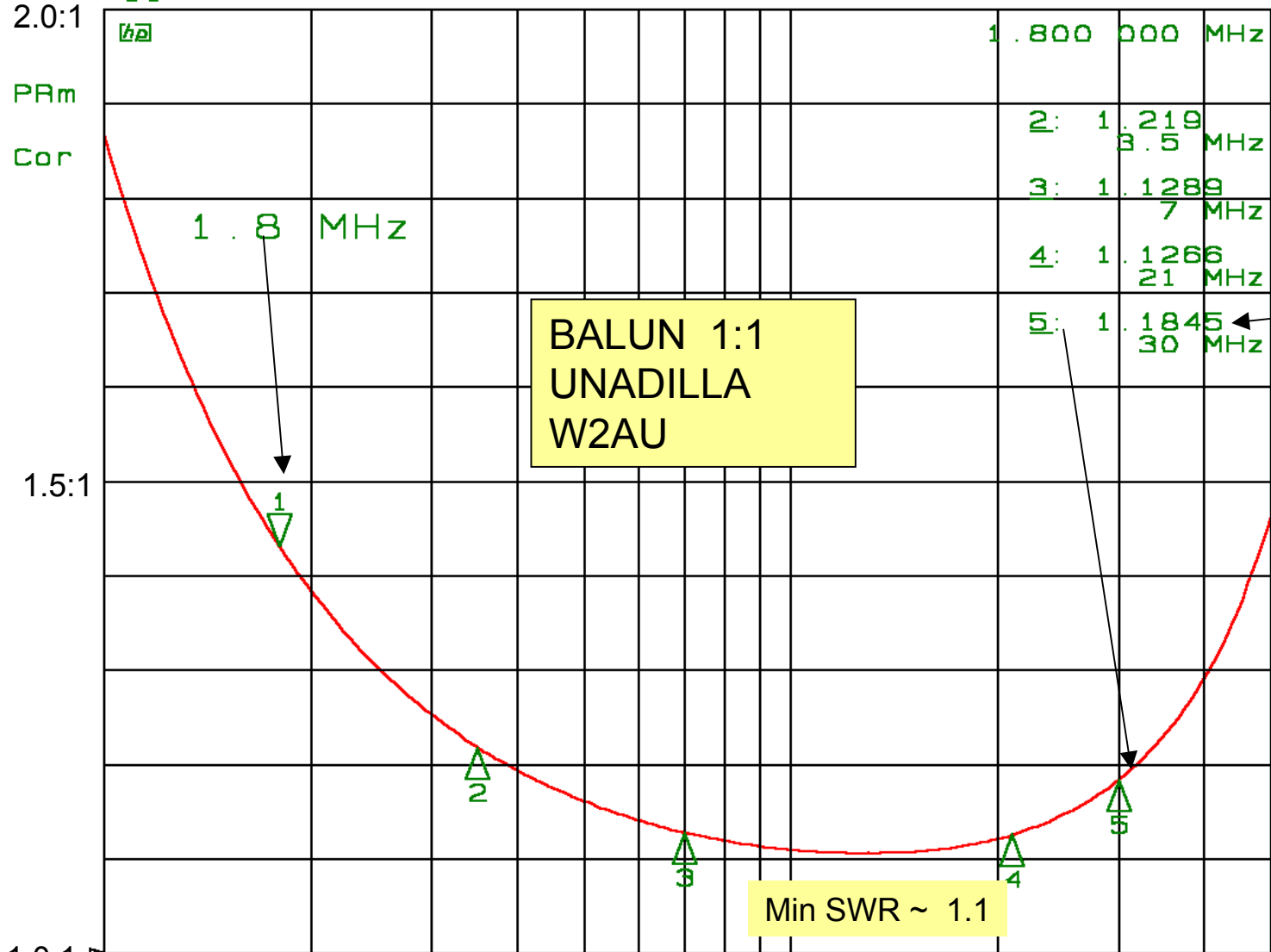

BALUN 1:1
UNADILLA
W2AU

Min SWR ~ 1.1

START 1.000 000 MHz STOP 50.000 000 MHz

1 MHz

10 MHz

50 MHz

20 Sep 2003 21:30:28

CH1 S₁₁ 400 mU FS 1: 44.363 Ω 16.041 Ω 1.4183 μH

1.800 000 MHz

PRm

Cor

SCALE
400 mUnits FS

2: 48.547 Ω

9.668 Ω

3.5 MHz

3: 50.367 Ω

6.0801 Ω

7 MHz

4: 55.604 Ω

8.164 Ω

21 MHz

5: 58.953 Ω

1.828 Ω

20 MHz

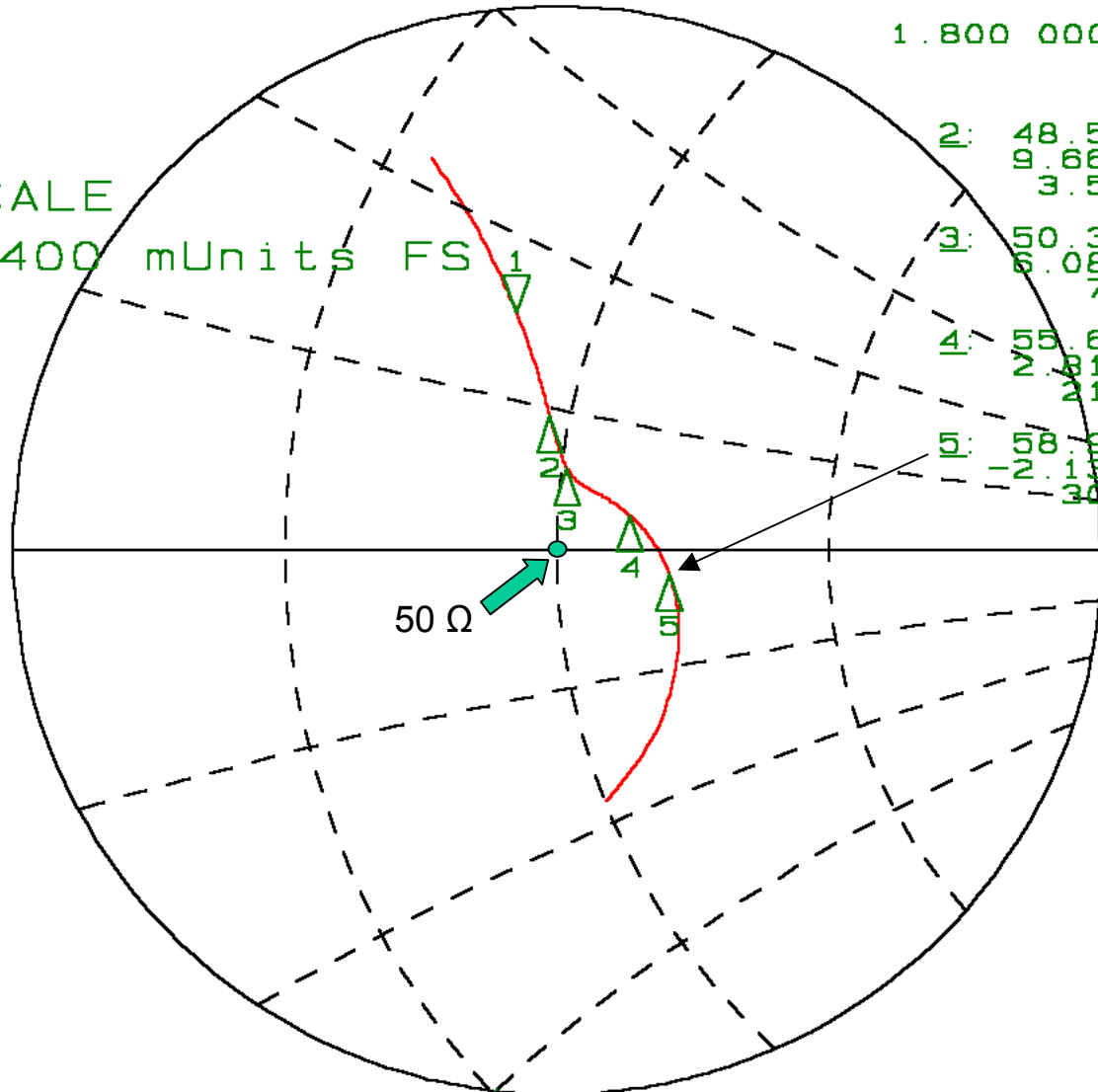

BALUN 1:1
UNADILLA
W2AU

IMPEDANCE
vs
Frequency
with a 50
ohm load

frequency
reactance
resistance

START 1.000 000 MHz STOP 50.000 000 MHz

CH1 S₁₁ SWR 500 m / REF 1 1: 2.7841

MEASURED SWR WITH A 50 ohms LOAD

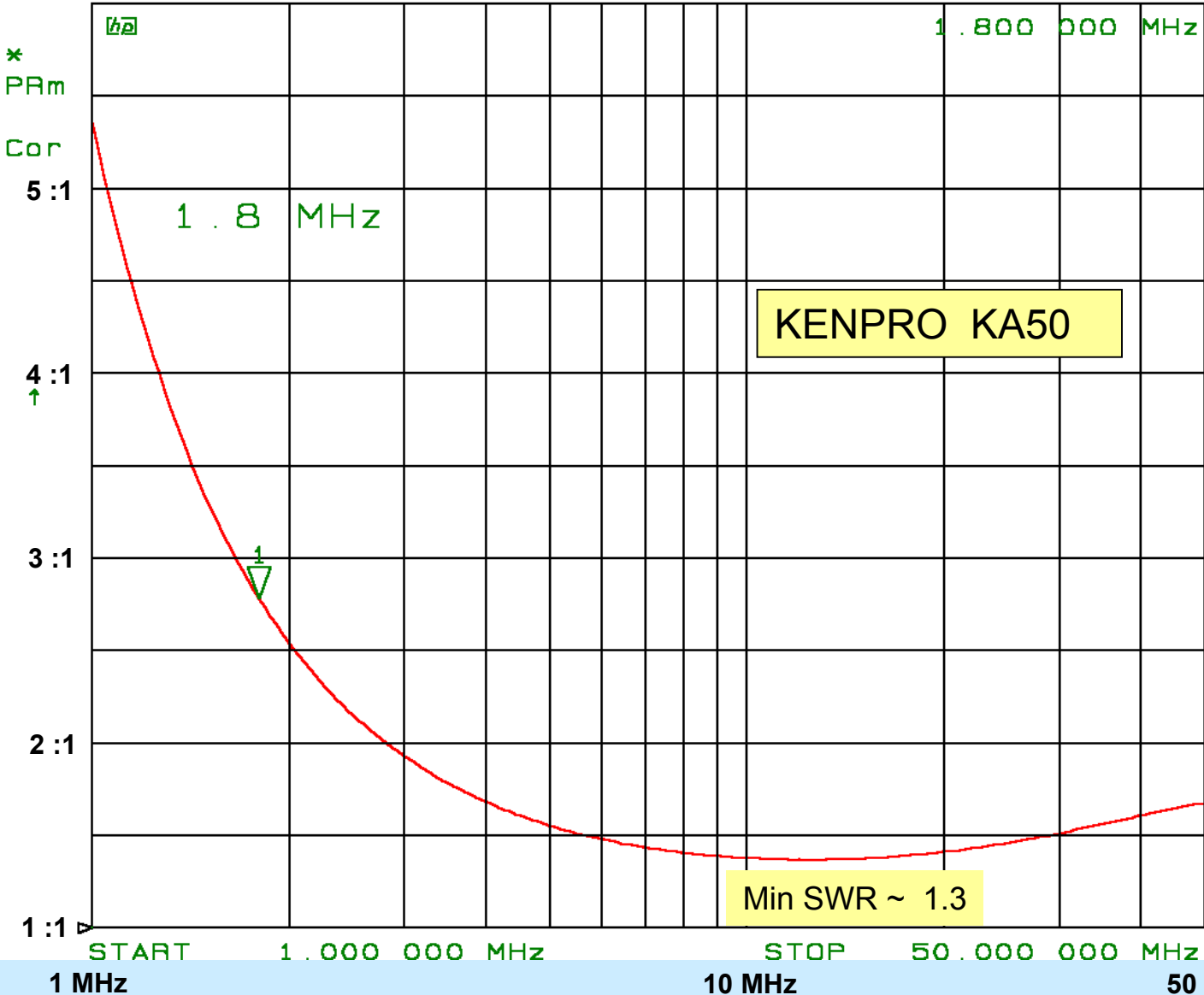

CH1 S₁₁ SWR 500 m / REF 1 4: 1.2785

14.000 000 MHz

PRM

Cor

5:1

4:1

3:1

2:1

1:1

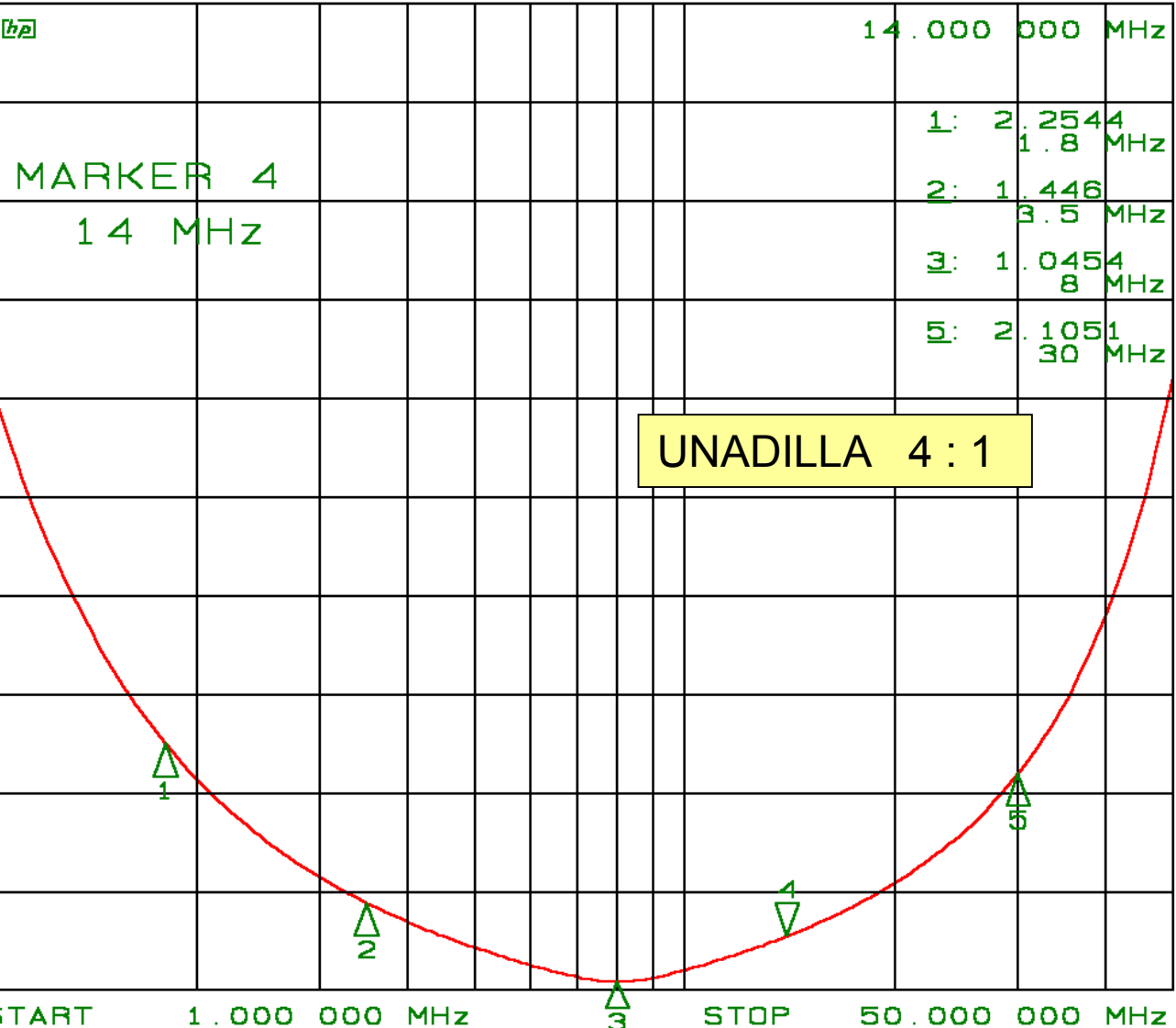

MEASURED SWR WITH A 200 ohms LOAD

START 1.000 000 MHz STOP 50.000 000 MHz

1 MHz

10 MHz

50 MHz

OPEN CIRCUIT TESTS WITH THE SWR ANALYZER

These tests verify:

- Winding inductance
- Winding distributed capacitance
- Quality of the winding insulation

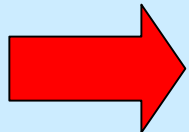
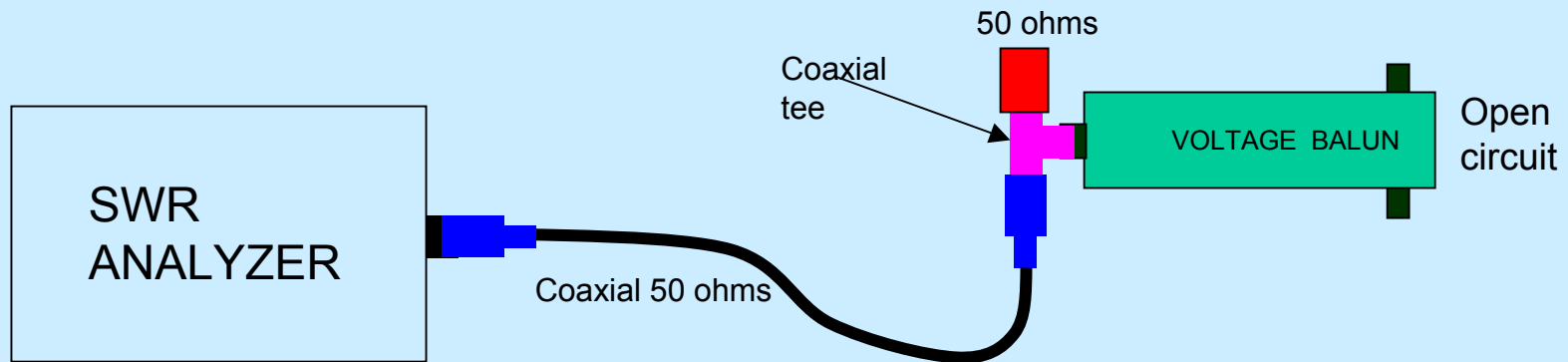

The minimum SWR should be below 1.1
In the middle of the balun's frequency range

Indicates low losses

OPEN CIRCUIT TESTS WITH THE SWR ANALYZER

23 Sep 2003 11:17:02

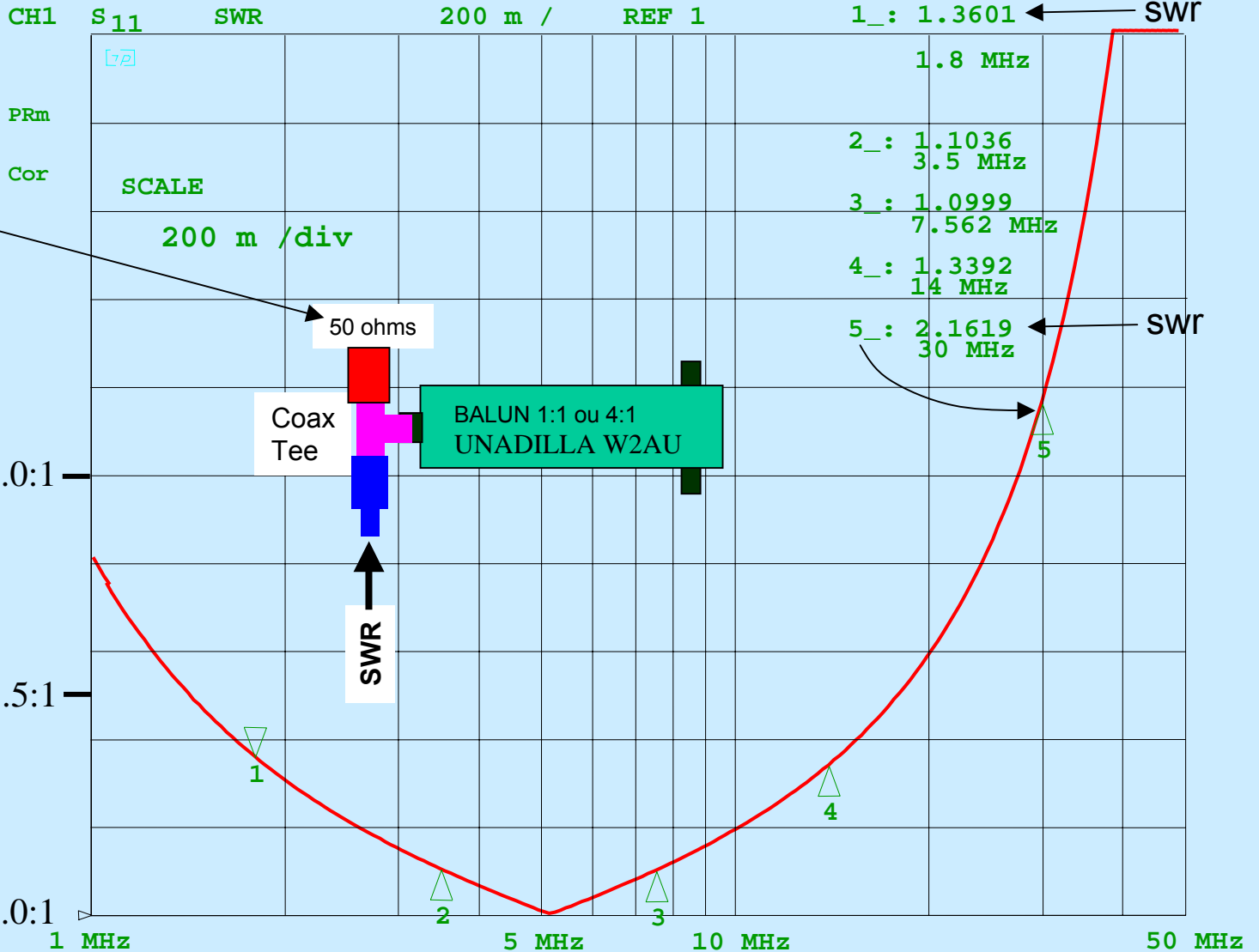

Always 50Ω
whatever
the Z ratio

MEASURED SWR

OPEN CIRCUIT TESTS WITH A VNA

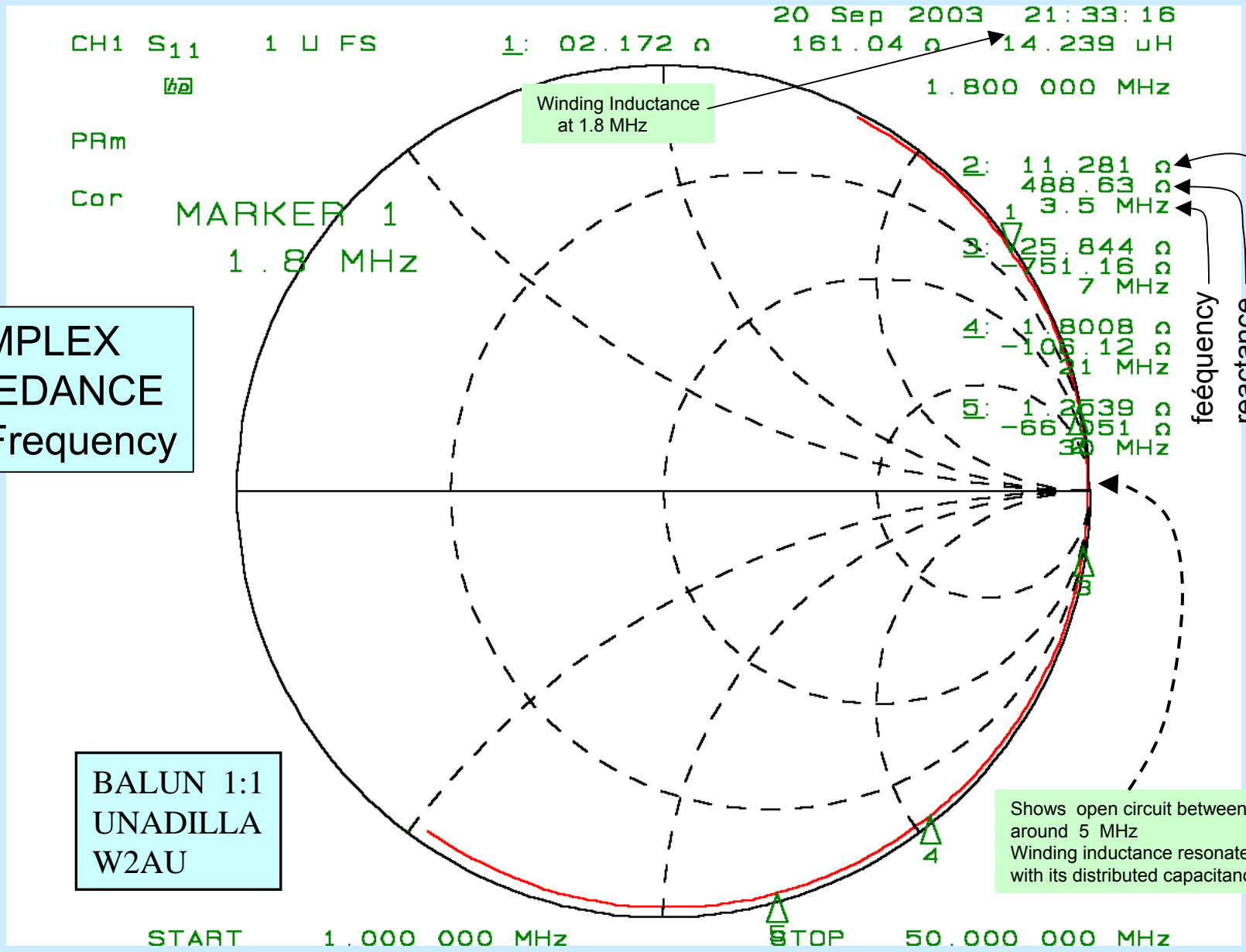

COMPLEX IMPEDANCE vs Frequency

BALUN 1:1
 UNADILLA
 W2AU

CURRENT BALUNS

QUESTION: How many independent conductors at RF frequencies do we have in a coaxial cable ? 1, 2, 3 ou 4 conductors ?

There are 3 independent conductors:

- The center conductor
- The inner surface of the shield
- The outer surface of the shield



Note that the RF current that flows on the outer surface of the shield is independent of the inner shield current.

This is so because at RF frequencies, the current penetrates very little inside the conductors. This is called SKIN EFFECT.

Note also that the SWR only applies to the inner shield currents (and center cond).
The SWR is independent of the outer shield currents.

SHIELDED LOAD

With a shielded load, the current stays inside the coax

There is no current on the outside of the coax

Adding ferrites on the outside of the coax has NO effect

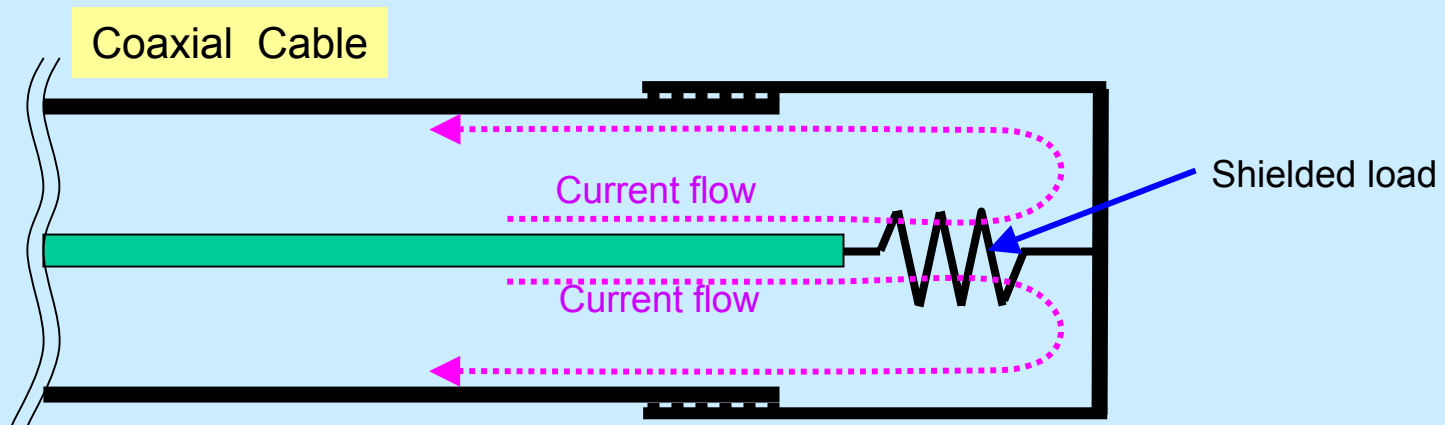

UNSHIELDED LOAD

A dipole is an unshielded load

Unshielded load causes current to flow on the outer surface of the coax

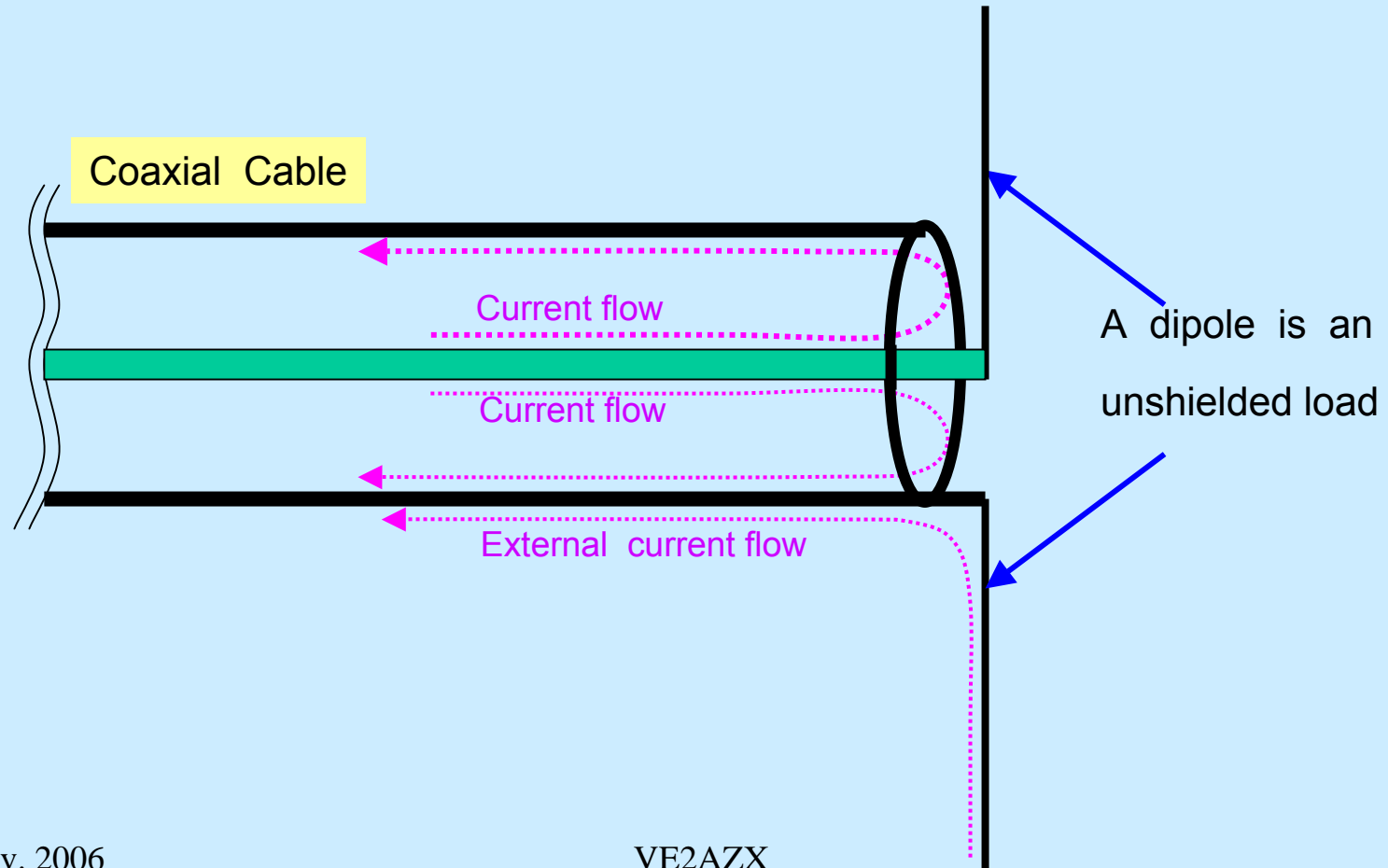

UNSHIELDED LOAD

Adding a ferrite core adds resistance on the OUTSIDE of the coax.

The ferrite core has NO effect on the internal coax currents

The ferrite core reduces the shield current

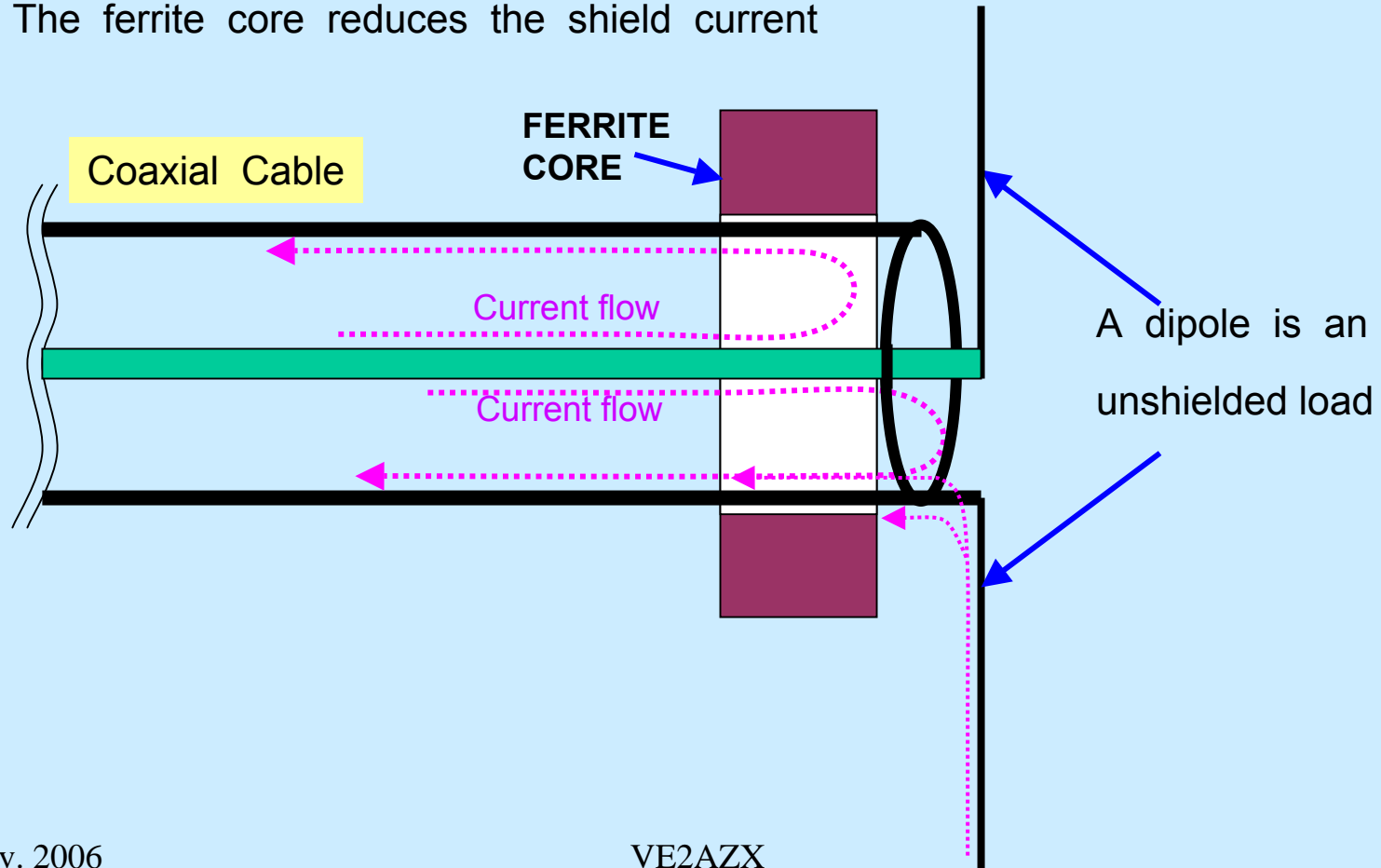

CURRENT BALUNS

How much Resistance is Required when Feeding a dipole with a coaxial cable ?

A coax cable feeds a dipole at its center, or with an offset

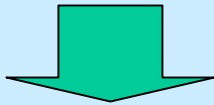

Equivalent Circuit
The coax is part of the antenna

$\lambda/4$ open stub
Is the **WORST** length – since it reflects a short

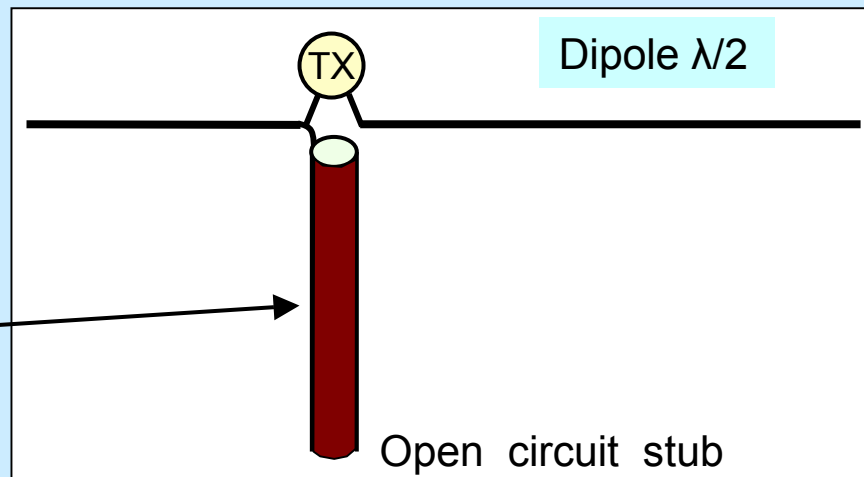
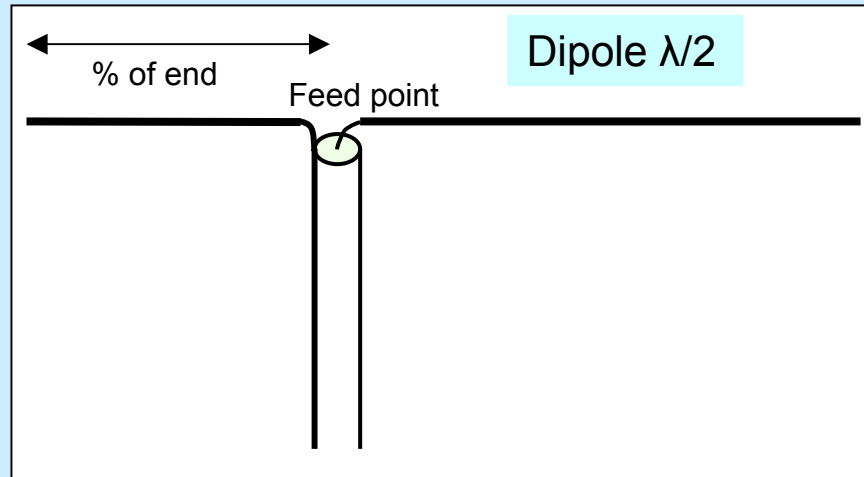

CURRENT BALUNS

Feeding a dipole with a coaxial cable

To decrease the stub current:
A current balun is inserted.
It adds a series impedance
on the outside of the coax.

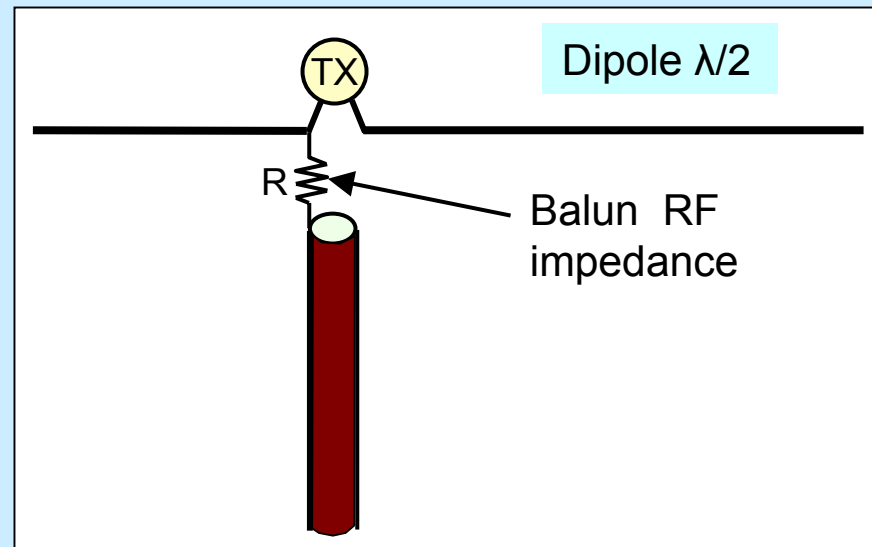
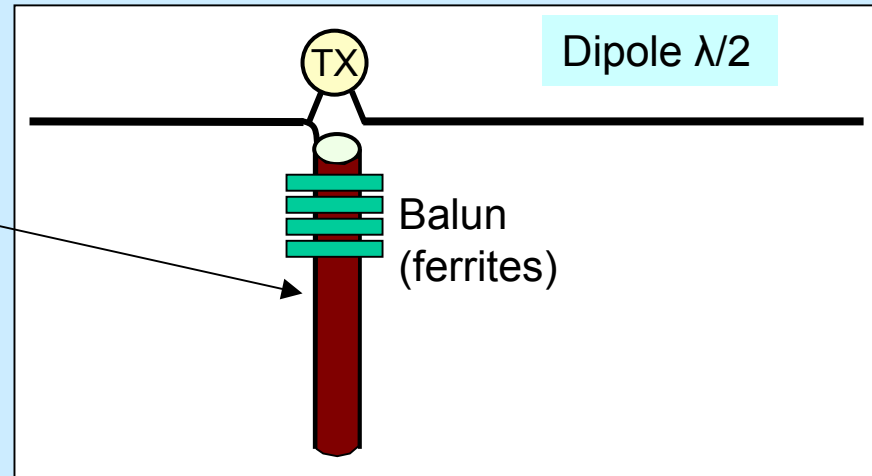
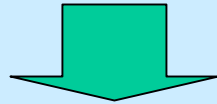

Balun Equivalent Circuit

What is the minimum value of
Impedance that I can have ...

That will have little effect on
the gain and impedance of
the dipole antenna ?

CURRENT BALUNS

Feeding a dipole with a coaxial cable

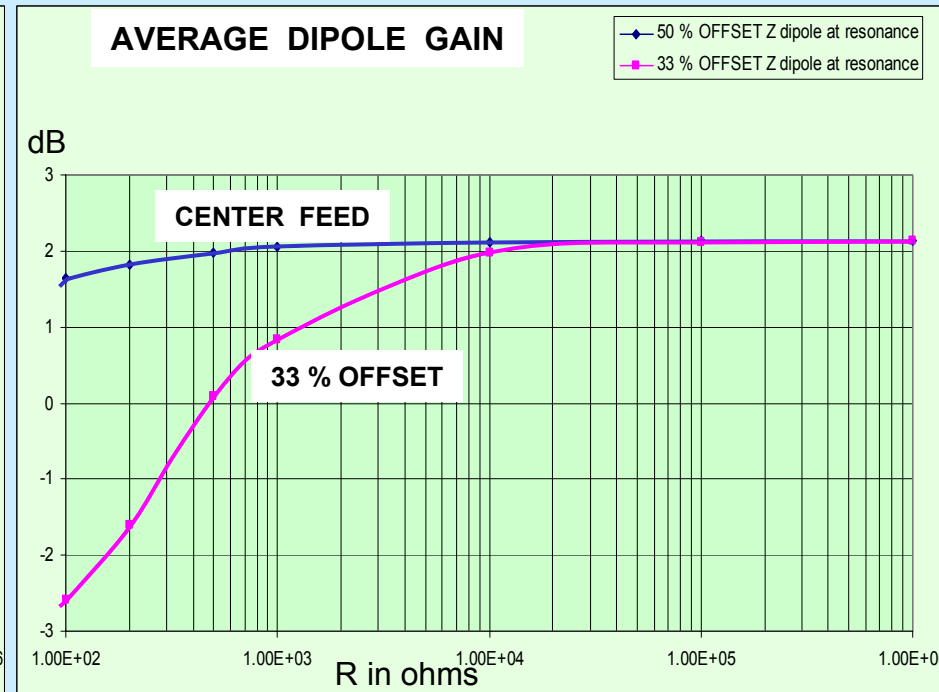
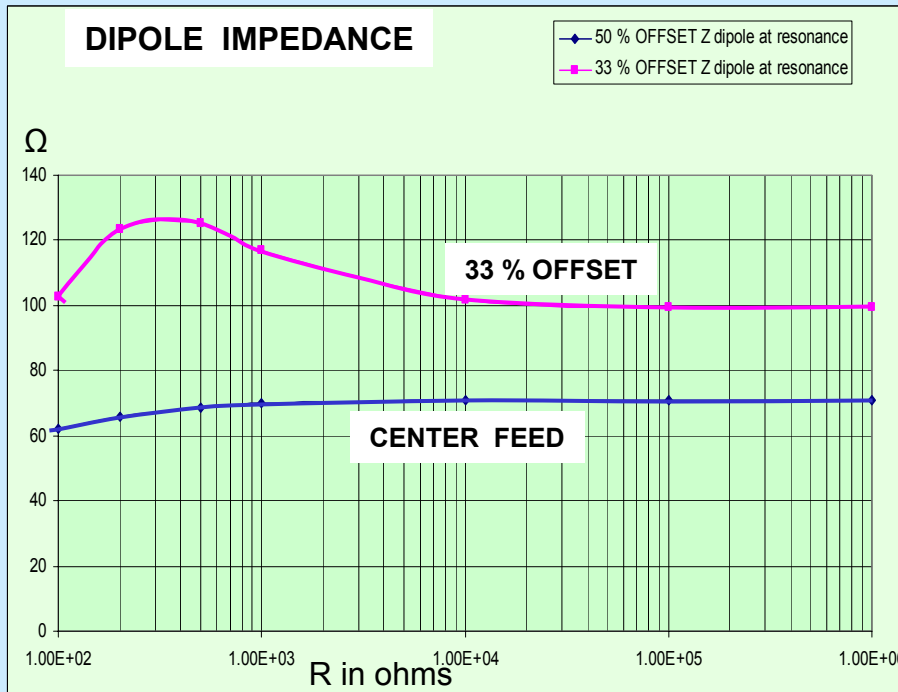
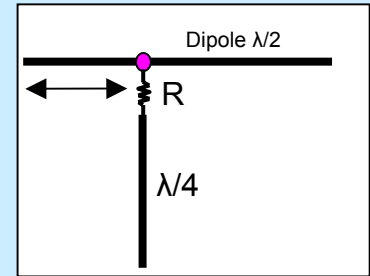

Feeding at the center (50%): $R > 1000$ ohms
 Feeding at 33% from end: $R > 10000$ ohms

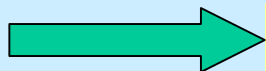

It's easier to feed at the center

CURRENT BALUNS

1:1 CURRENT BALUN

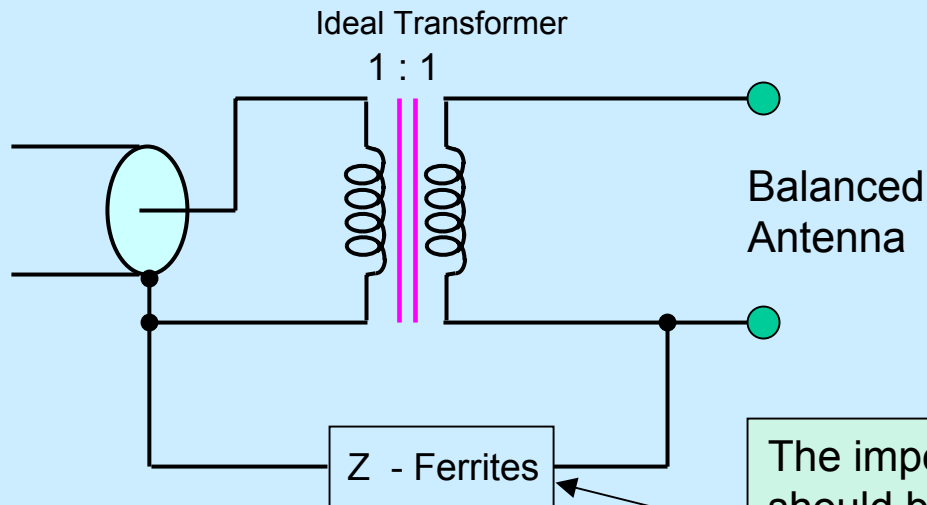
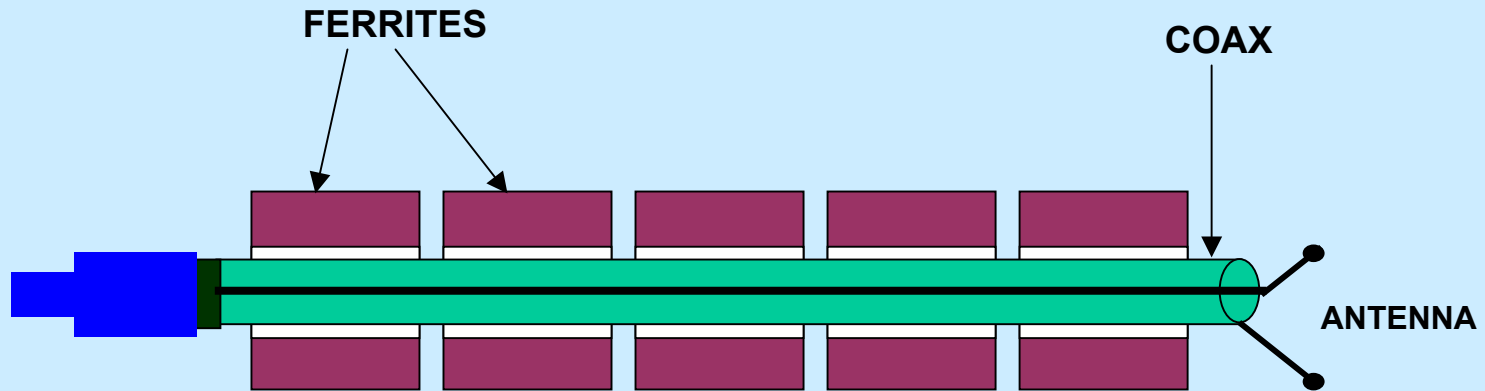

Equivalent
Circuit at RF

The impedance of the ferrites
should be high (> 1000 ohms)
for a well balanced output

FERRITE IMPEDANCE

DEPENDS ON...

- MATERIAL
- LENGTH
- VOLUME OF MATERIAL
- VARIES WITH FREQUENCY

- TO CALCULATE THE IMPEDANCE Z: (approx.)

IMPEDANCE OF ONE TURN FOR ONE FERRITE
multiplied by...
NUMBER OF FERRITES
multiplied by ...
(NUMBER OF TURNS) squared

- NOTE: 1 TURN = FERRITE ON A STRAIGHT WIRE

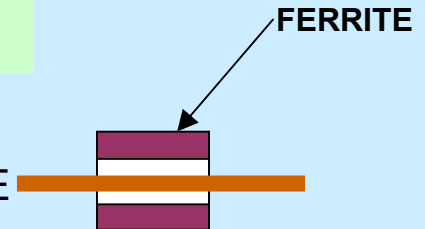

FERRITE IMPEDANCE

- FERRITES VS IRON POWDER ... TWO DIFFERENT MATERIALS

- **FERRITE**: HAS A HIGH PERMEABILITY (10 to 15000)
GIVING A HIGH INDUCTANCE FOR A SMALL NUMBER OF TURNS

BUT THE INDUCTANCE OBTAINED IS NOT STABLE AND Q FACTOR IS LOW

OK FOR TRANSFORMERS AND BALUNS
- **IRON POWDER**: LOWER PERMEABILITY ... LOWER INDUCTANCE,
GIVES A STABLE, HIGH Q INDUCTANCE (EX.: VFO, FILTERS, TUNERS)

MEASUREMENT OF FERRITE IMPEDANCE

USING AN SWR ANALYZER OR A VECTOR NETWORK ANALYZER

Allow measuring separately the Resistive and Inductive Components

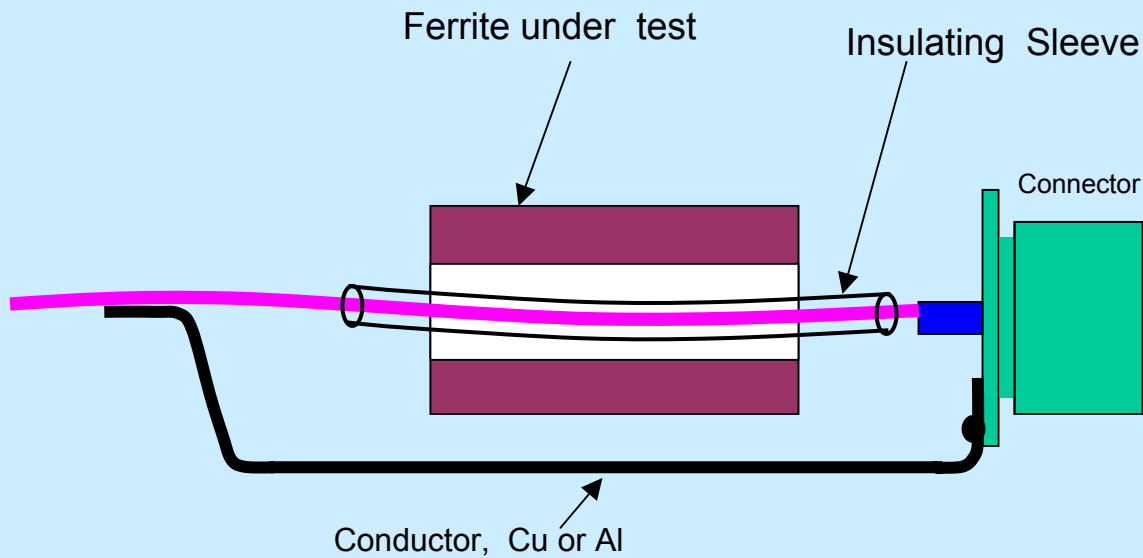

SWR ANALYZER
With IMPEDANCE CAPABILITY
- OR -
VECTOR NETWORK
ANALYZER



IMPEDANCE MEASUREMENTS



CLAMP ON FERRITE
FOR RG-8

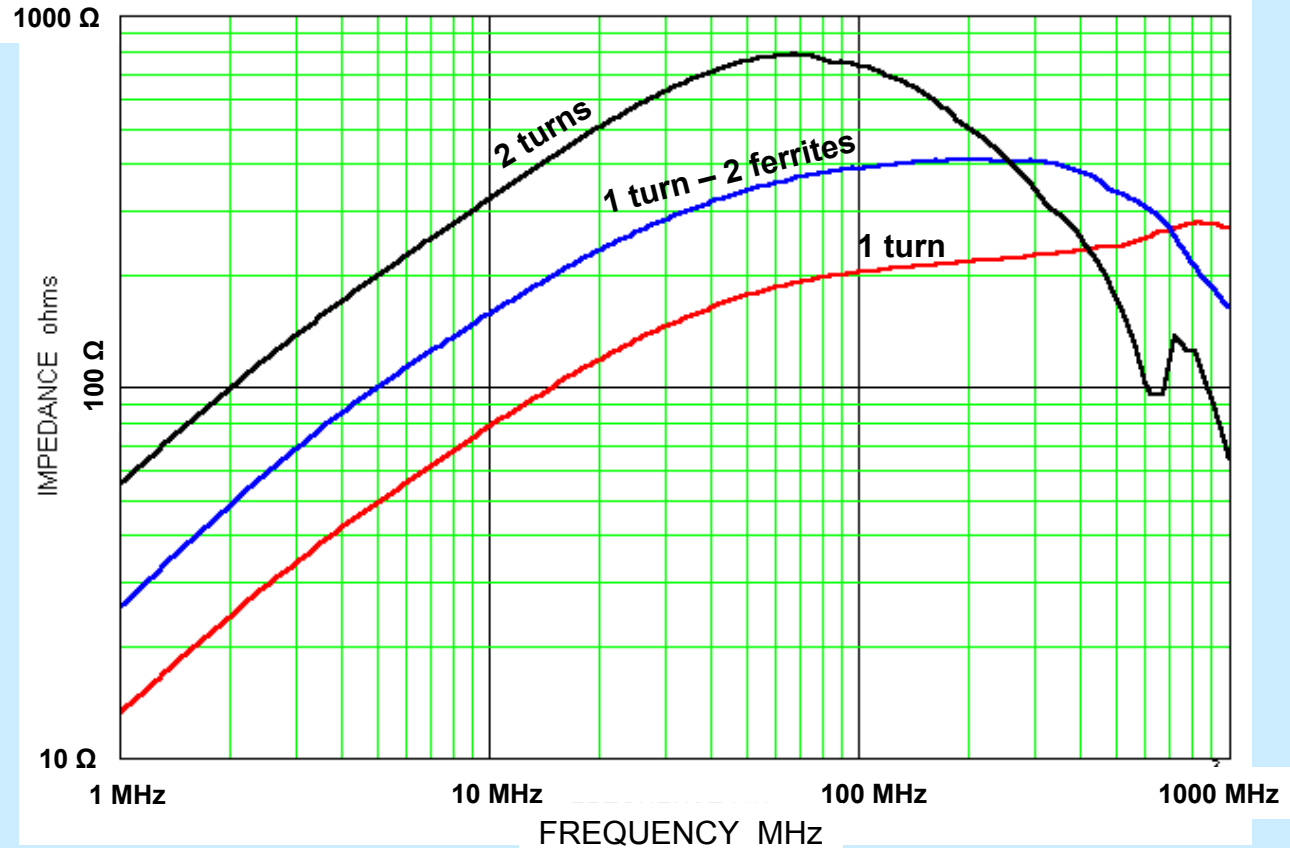

YIELDS 80 ohms at 10 MHz for 1 turn

IMPEDANCE MEASUREMENTS



- ABOVE 20 MHz THE Q FACTOR < 1
THE IMPEDANCE BECOMES RESISTIVE

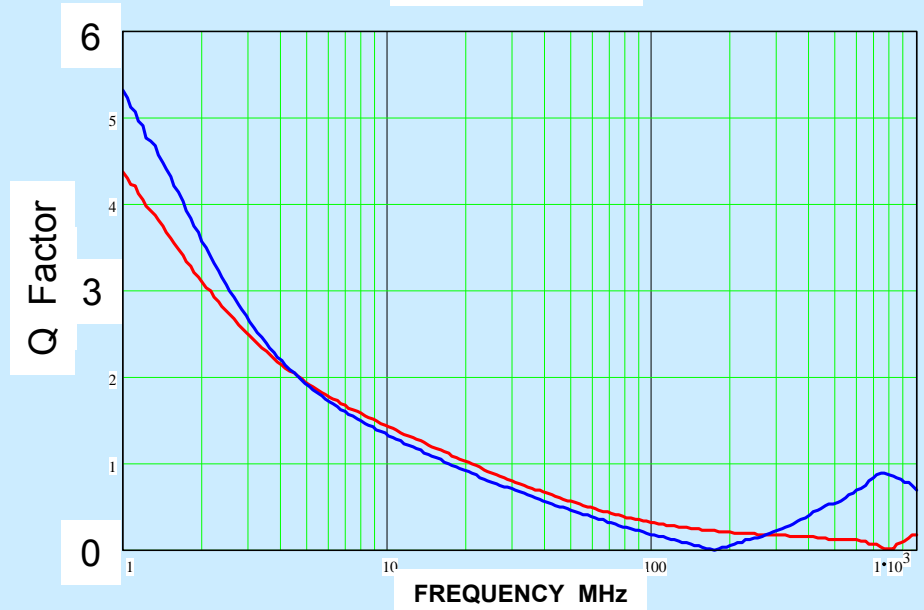
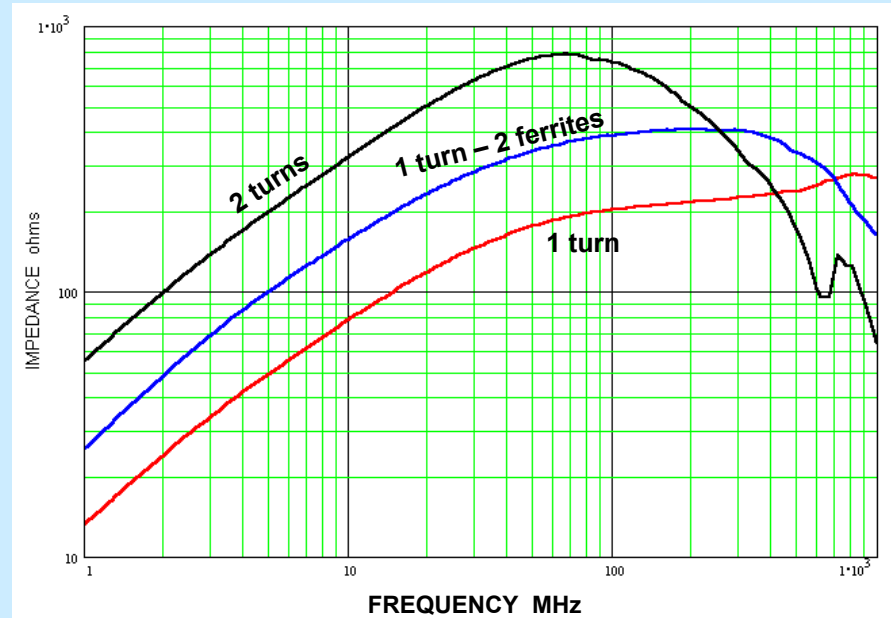

IMPEDANCE MEASUREMENTS

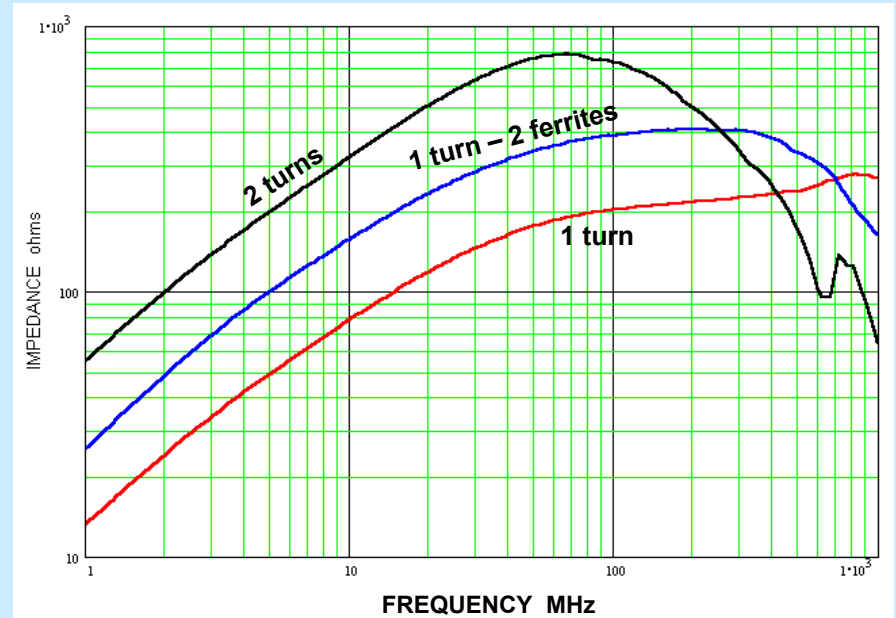

- THE INDUCTANCE DECREASES AS THE FREQUENCY IS INCREASED
- THE INDUCTANCE DISAPPEARS WHEN $F > 100$ MHz

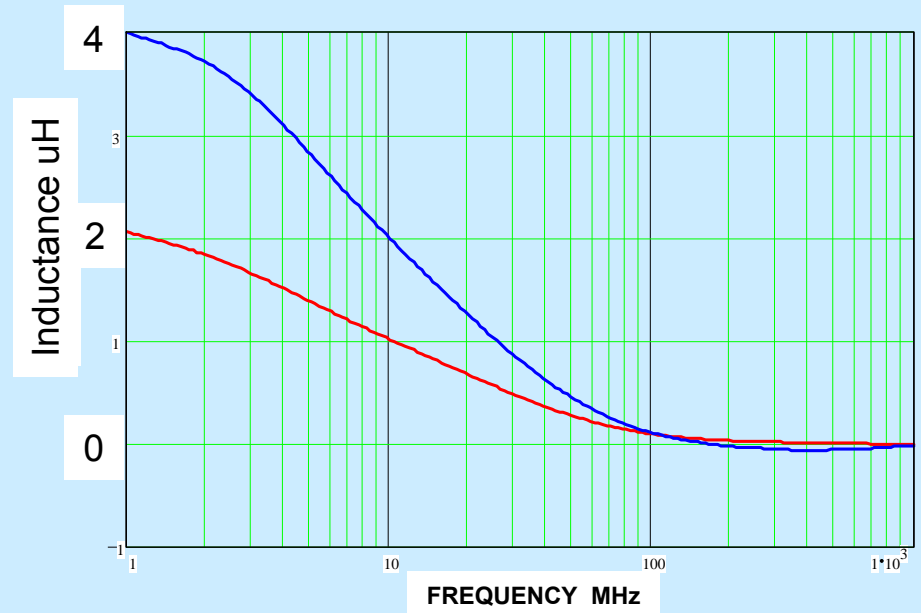

IMPEDANCE MEASUREMENTS

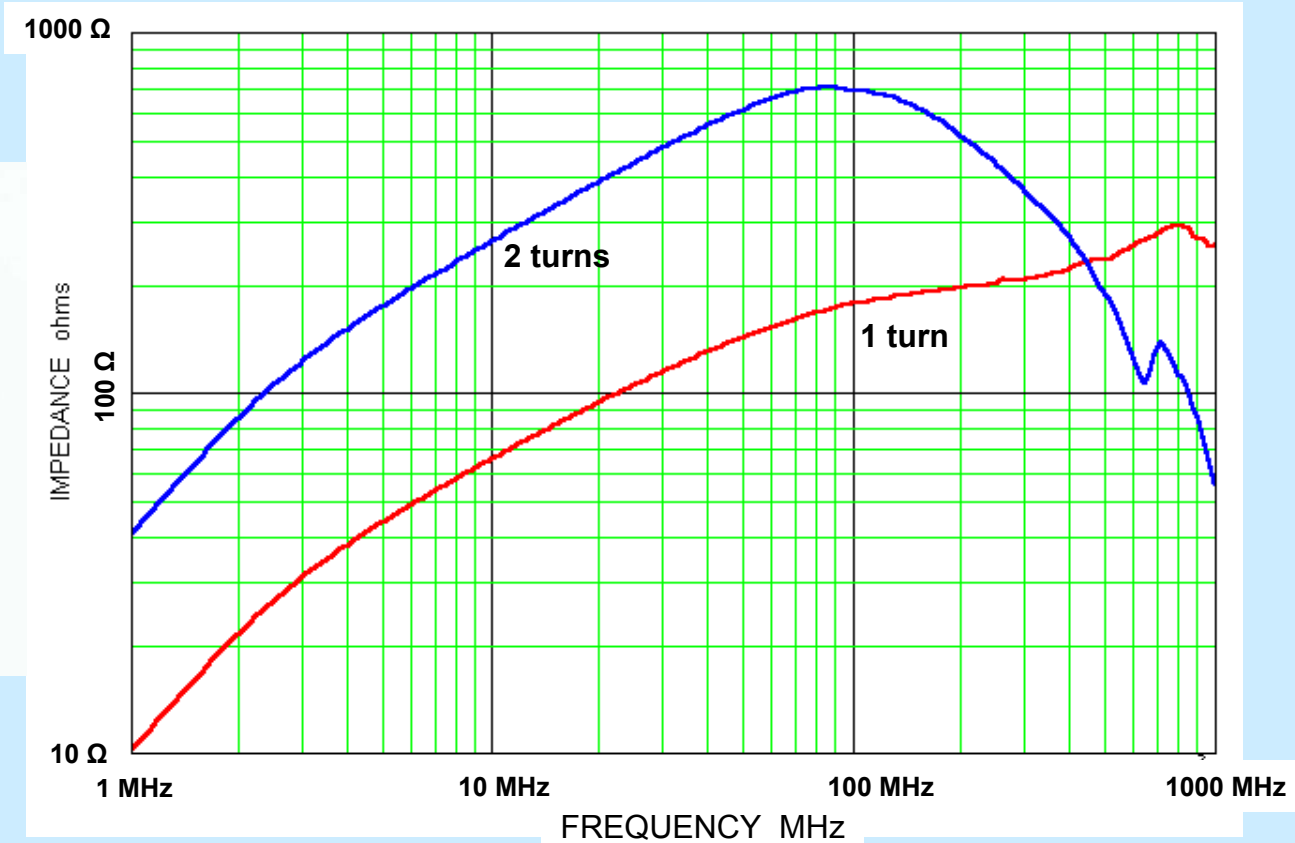

- THIS IMPEDANCE CURVE IS SIMILAR TO THE PREVIOUS CORE

IMPEDANCE MEASUREMENTS

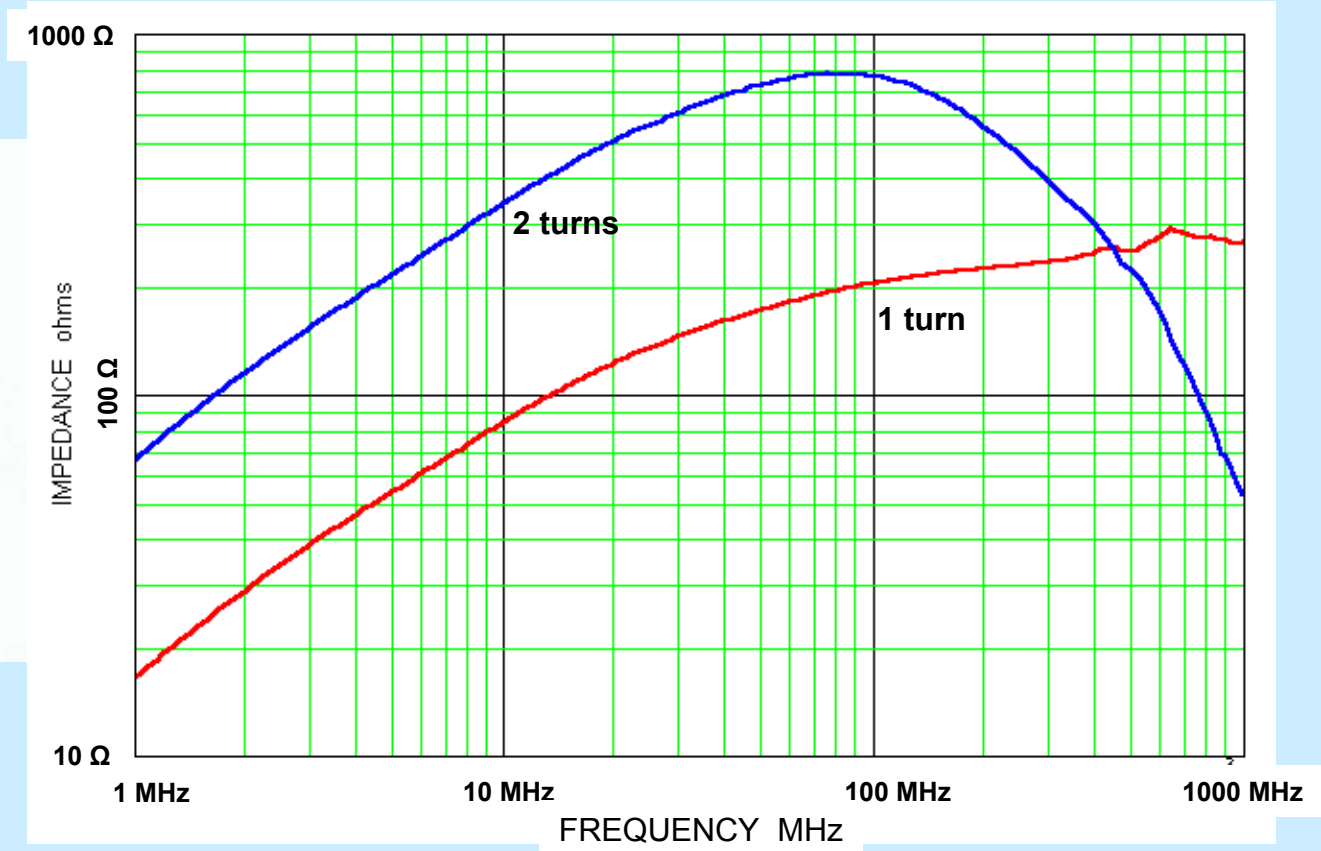

- THIS IMPEDANCE CURVE IS SIMILAR TO THE PREVIOUS CORE

IMPEDANCE MEASUREMENTS



RECTANGULAR
CLAMP-ON FERRITE

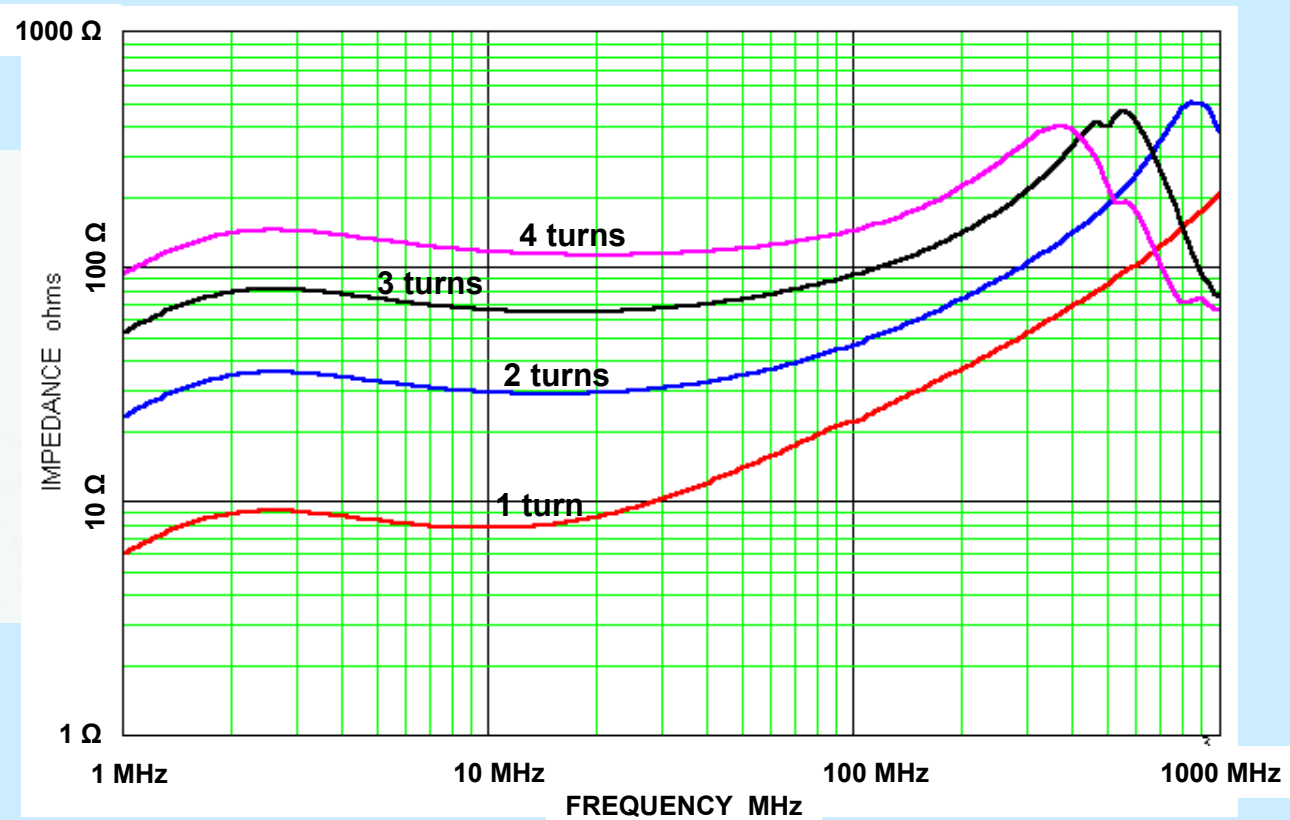

- GIVES ~ 10% IMPEDANCE OF PREVIOUS CORES (8 ohms at 10 MHz for 1 turn)
- COVERS MUCH WIDER FREQUENCY RANGE
- SHOULD USE MANY TURNS: 10 TURNS GIVE 800 ohms AT 10 MHz

IMPEDANCE MEASUREMENTS



RECTANGULAR
CLAMP-ON FERRITE

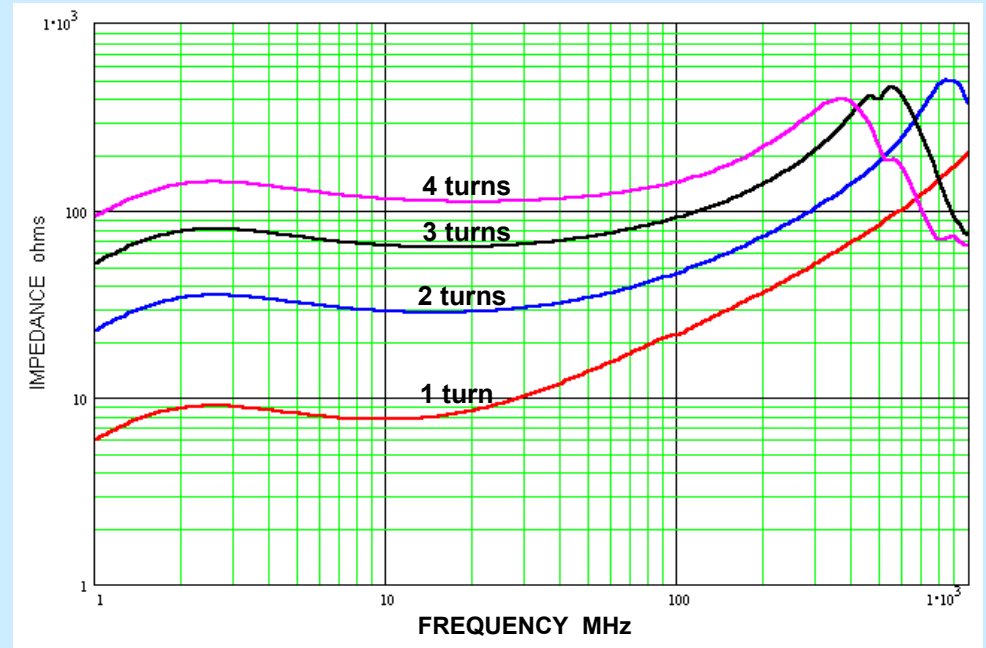

- THE INDUCTANCE DISAPPEARS
ABOVE 6 MHz

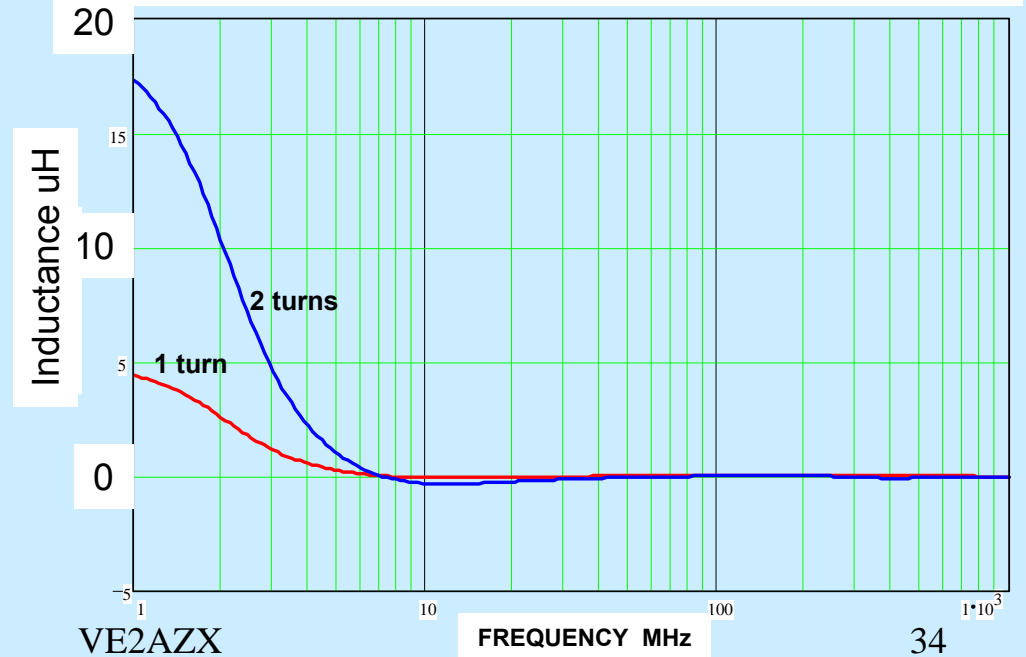

IMPEDANCE MEASUREMENTS



STACKED
RECTANGULAR
CLAMP-ON FERRITE

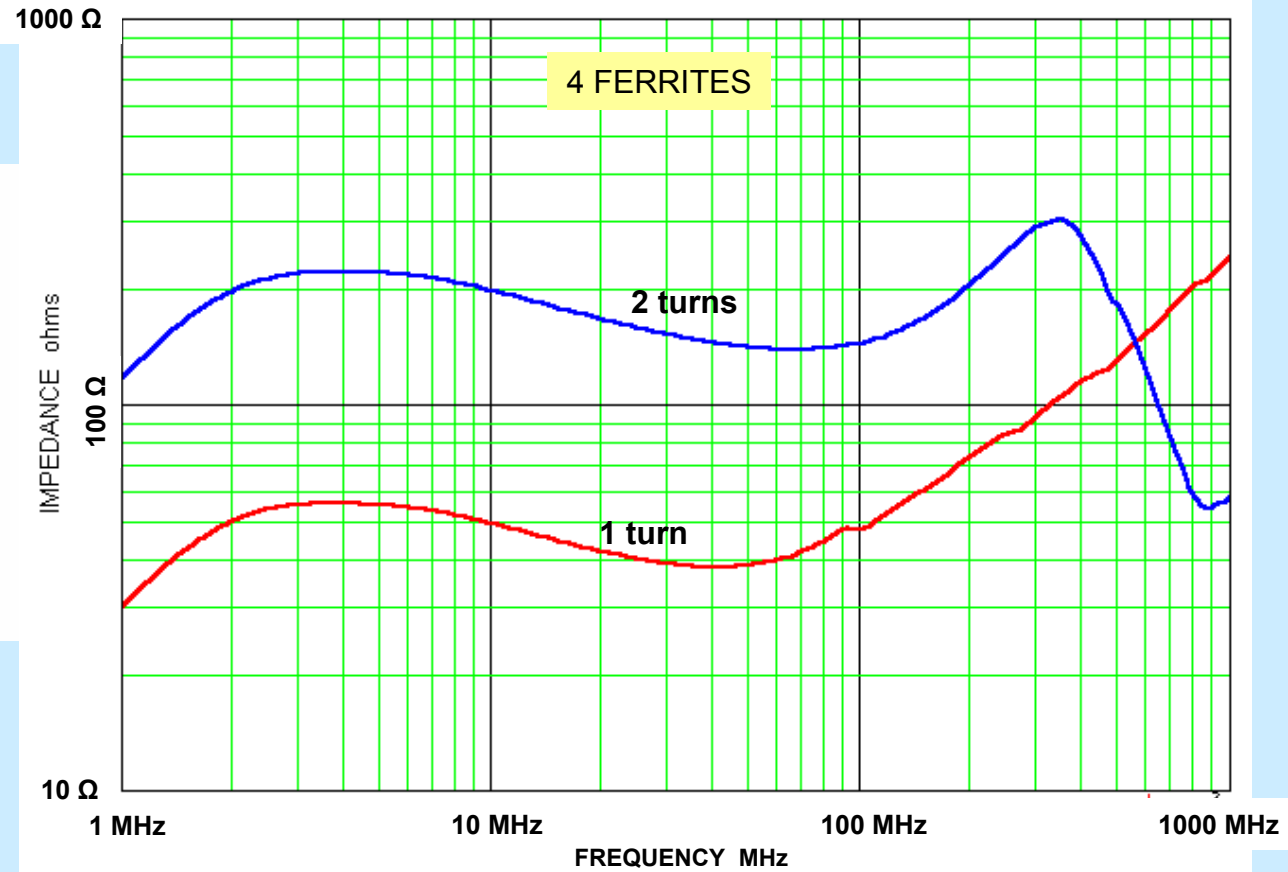

4 TURNS WILL YIELD ~ 800 ohms

TESTING A FERRITE BEAD

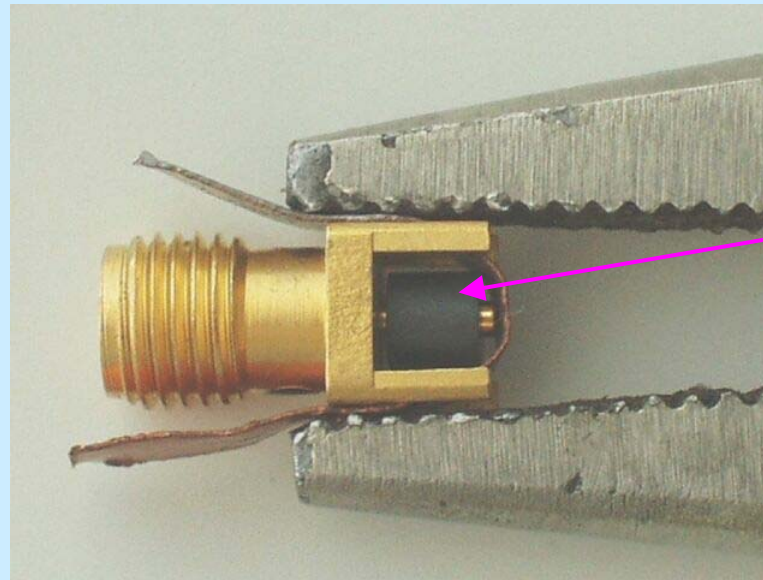

FERRITE BEAD
APPROX. 0.1 PO. LONG.

ohms

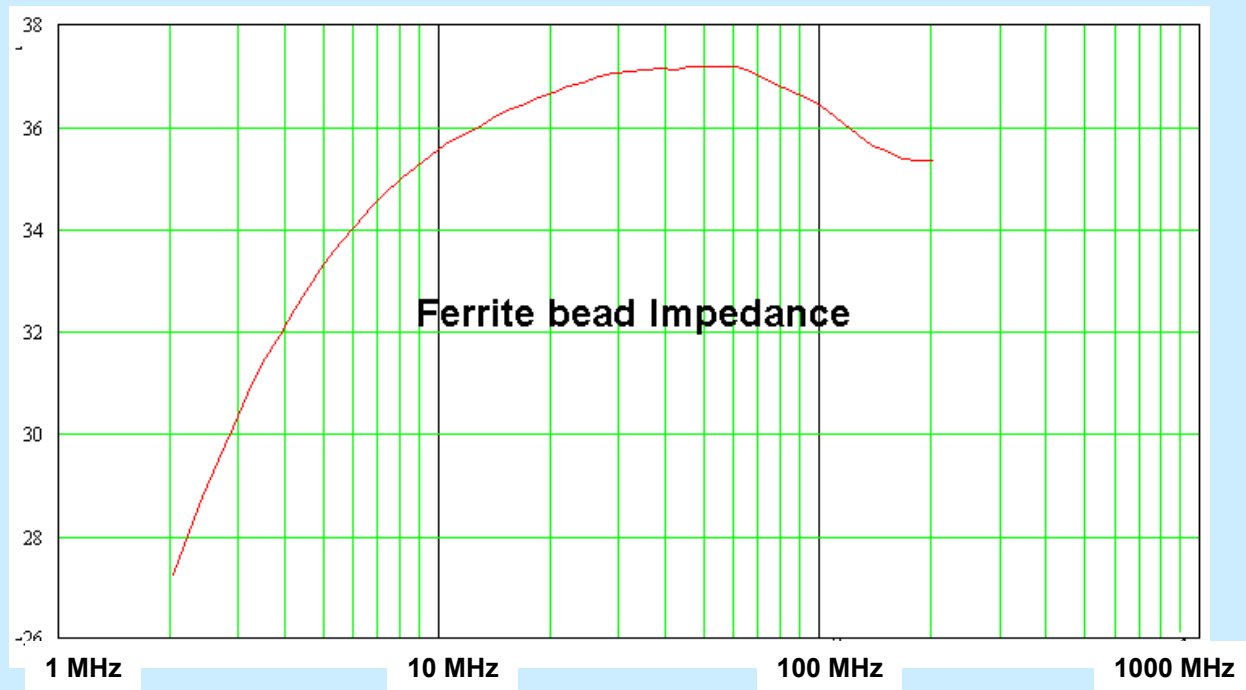

IMPEDANCE MEASUREMENTS

FREQUENCY RESPONSE MODE

- Does NOT allow measuring separately the Resistive and Inductive components
- Ease of sweeping the frequency
- Reference level = 0 dB = short in place of ferrite

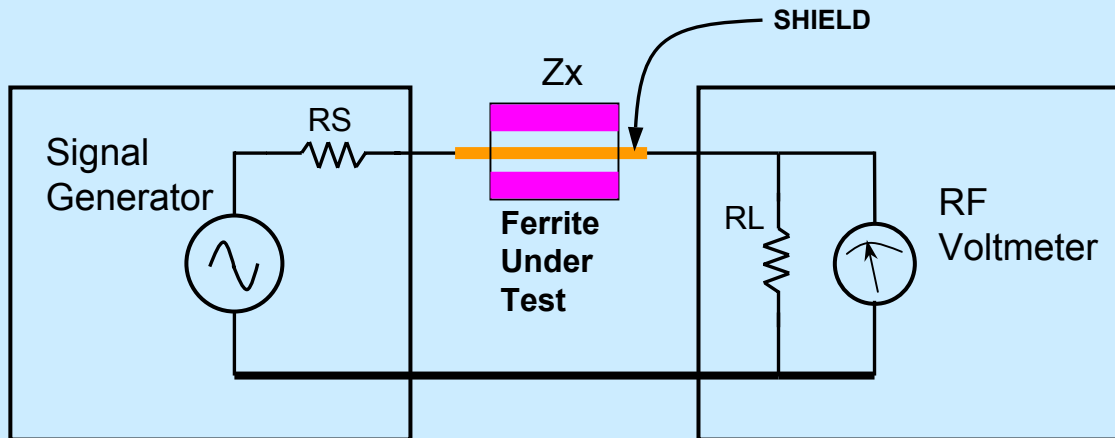

R_S and R_L are generally 50 ohms

To calculate Z_x from attenuation readings in + dB's:
(assumes that Z_x is resistive)

$$Z_x = (R_L + R_S) \cdot (10^{\left[\frac{\text{dB}}{20}\right]} - 1)$$

IMPEDANCE MEASUREMENTS

(Done in frequency response mode)



6 toroids 4 turns

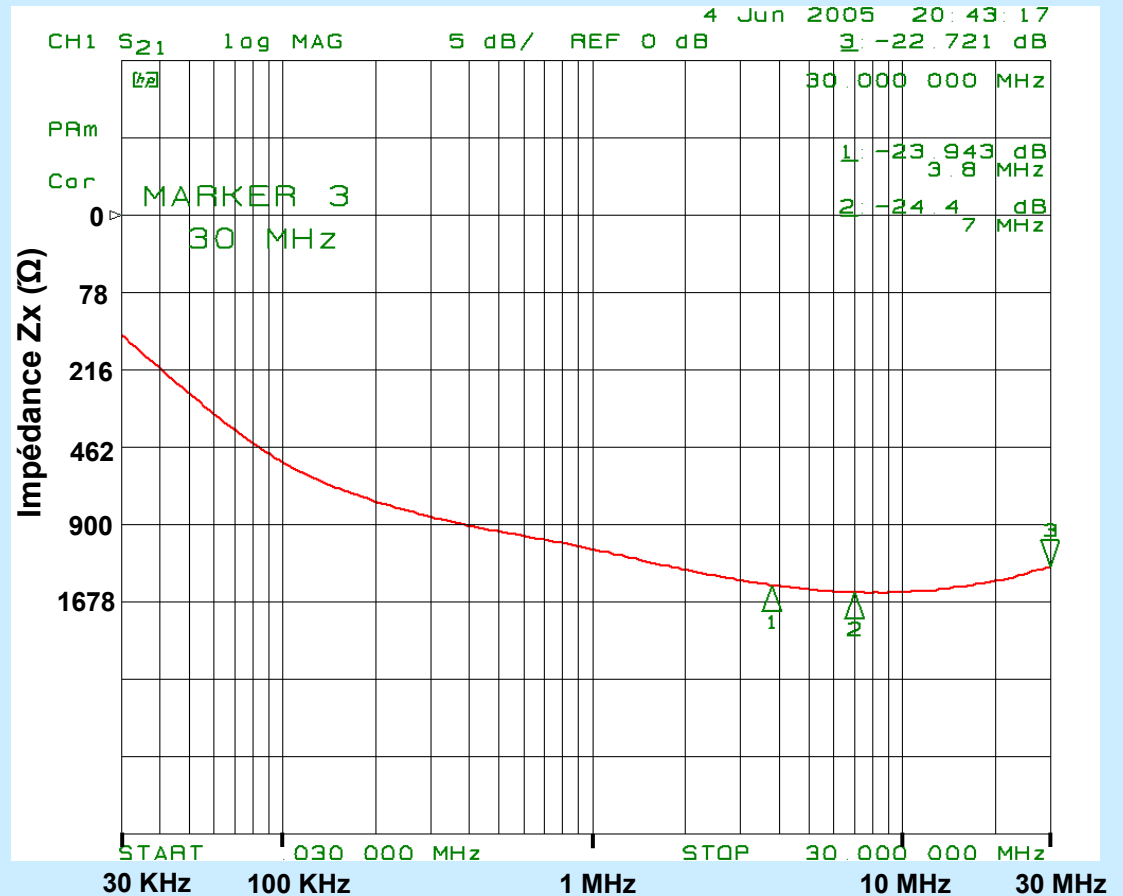

IMPEDANCE MEASUREMENTS

(Done in frequency response mode)



6 toroids 6 turns

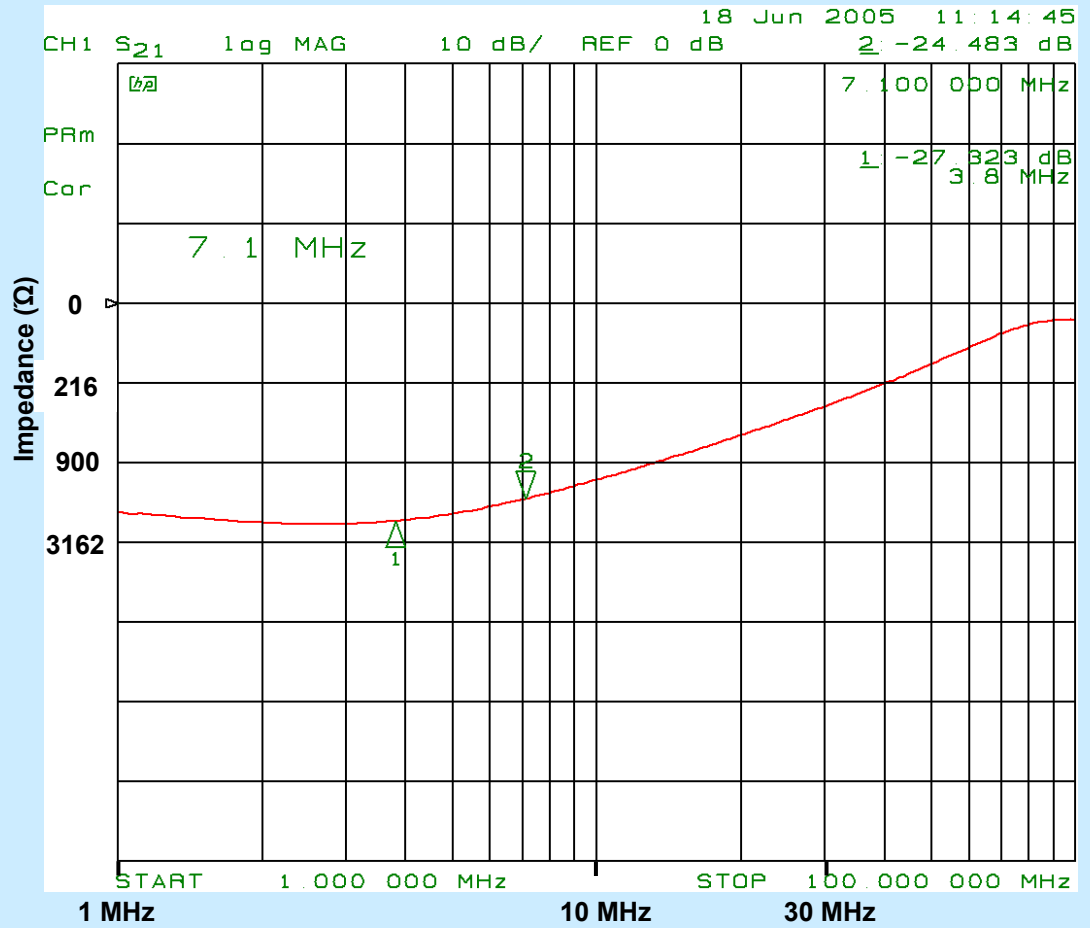

IMPEDANCE MEASUREMENTS

(Done in frequency response mode)



2 toroids
1 turn

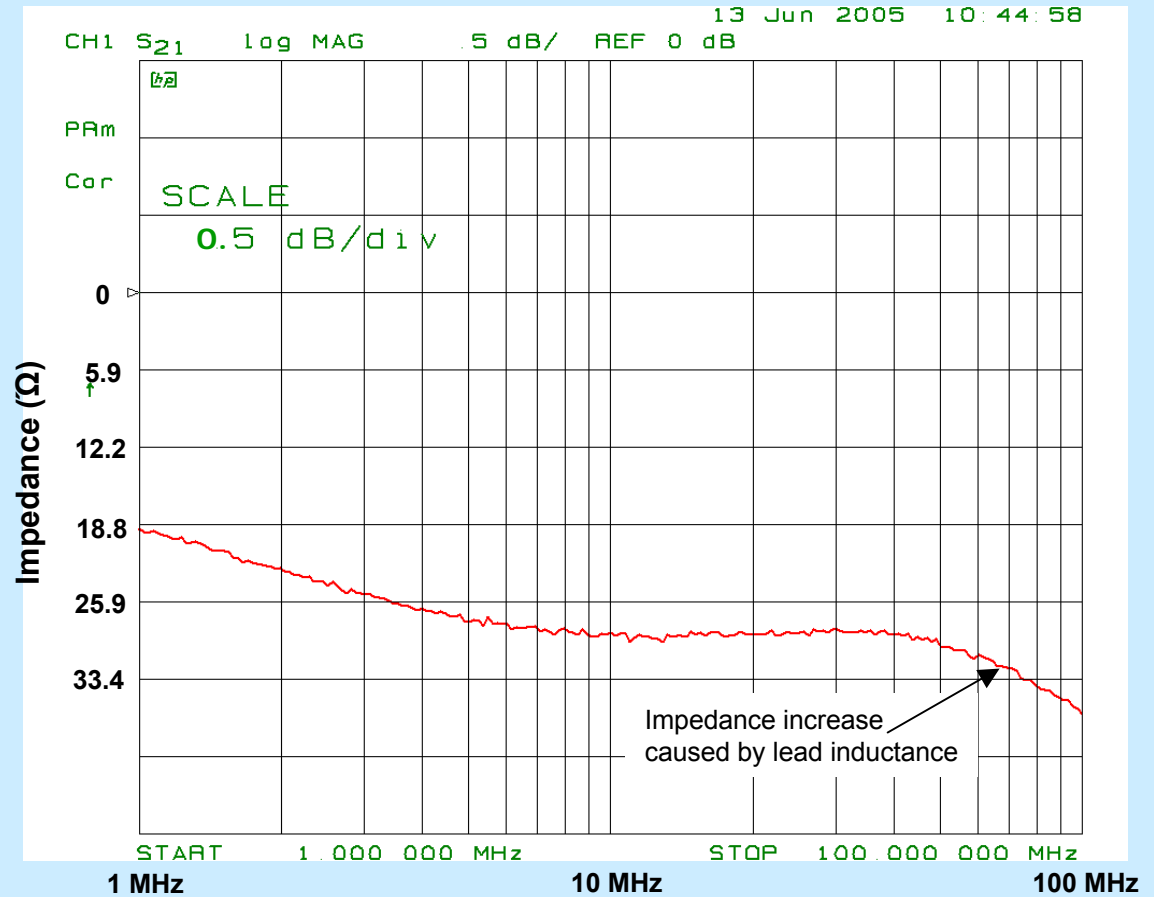

IMPEDANCE MEASUREMENTS

(Done in frequency response mode)



2 toroids 5 turns

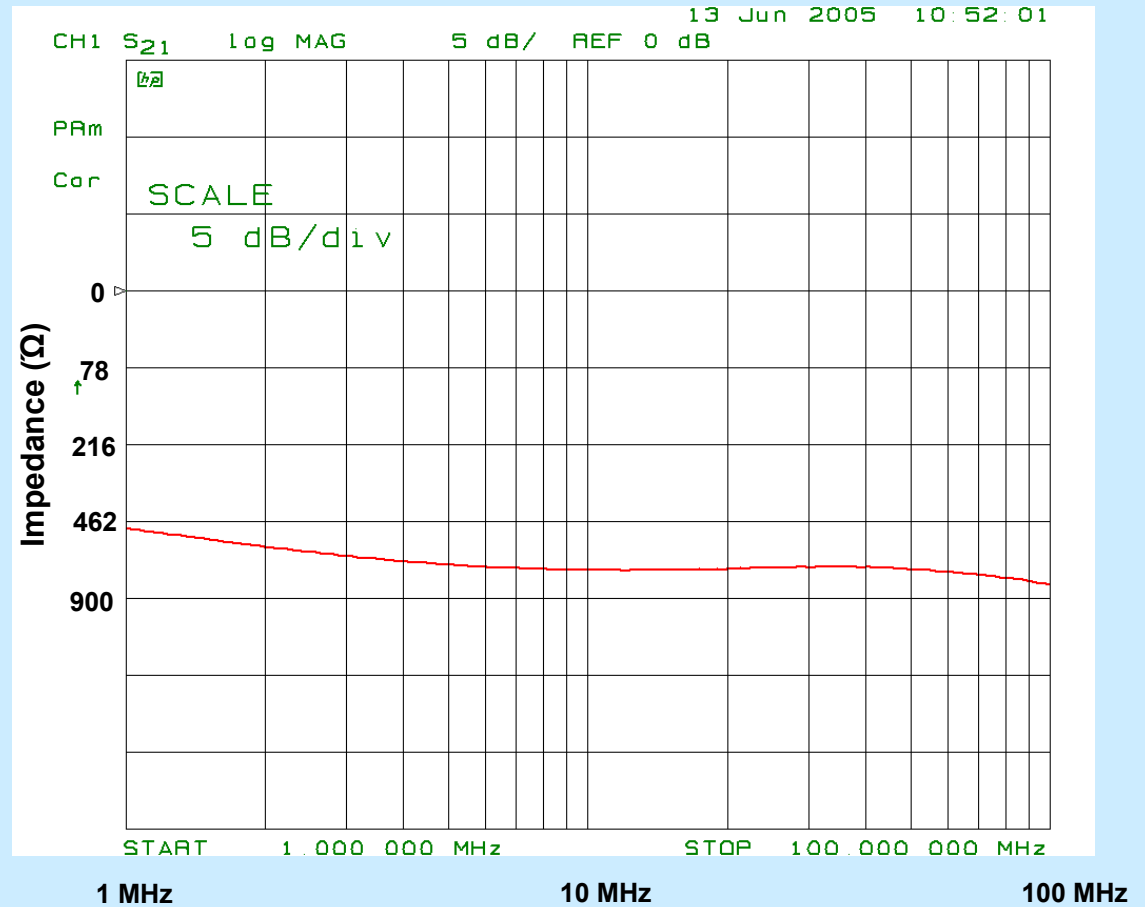

IMPEDANCE MEASUREMENTS

(Done in frequency response mode)

Coax with 25, #43 beads

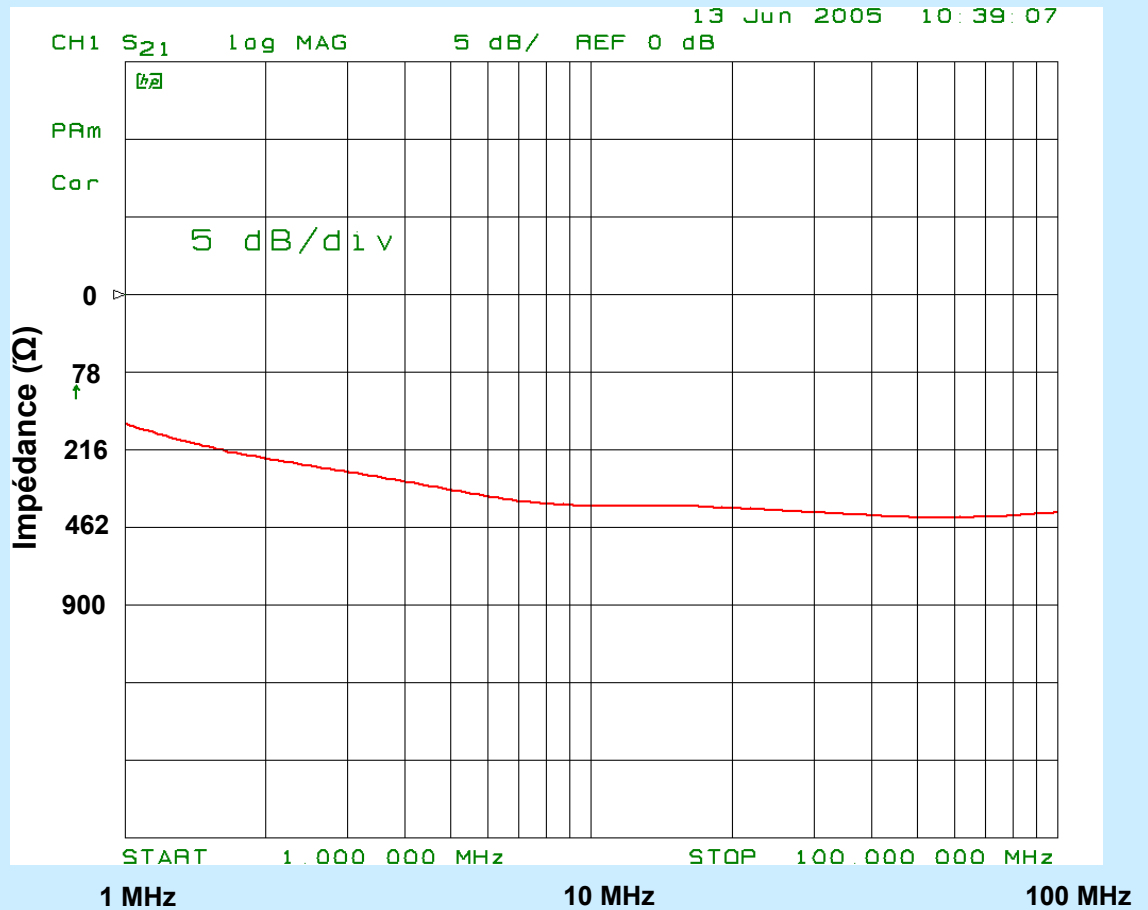

IMPEDANCE MEASUREMENTS

(Done in frequency response mode)

#14 Wire with 50 beads #73



Excellent at HF

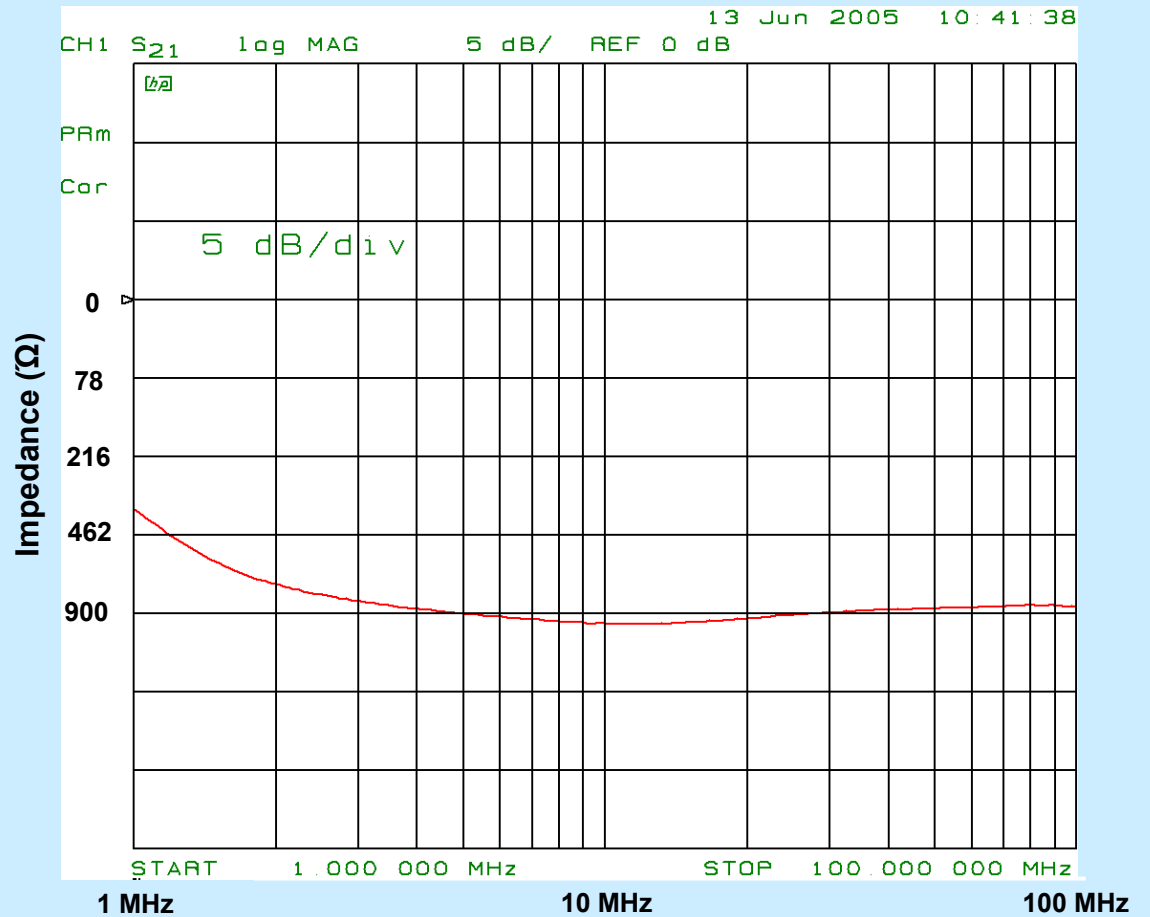

CHECK YOUR FERRITES WITH YOUR SWR ANALYZER

FROM SWR MEASUREMENTS

Coax cable shield
Allows for many turns.

Ferrite under test

Insulating Sleeve

Male UHF Connector

SWR ANALYZER

Conductor, Cu or Al

50 Ω

The ferrite is in parallel with the 50 ohms (1%) termination

FERRITE IMPEDANCE VS MEASURED SWR

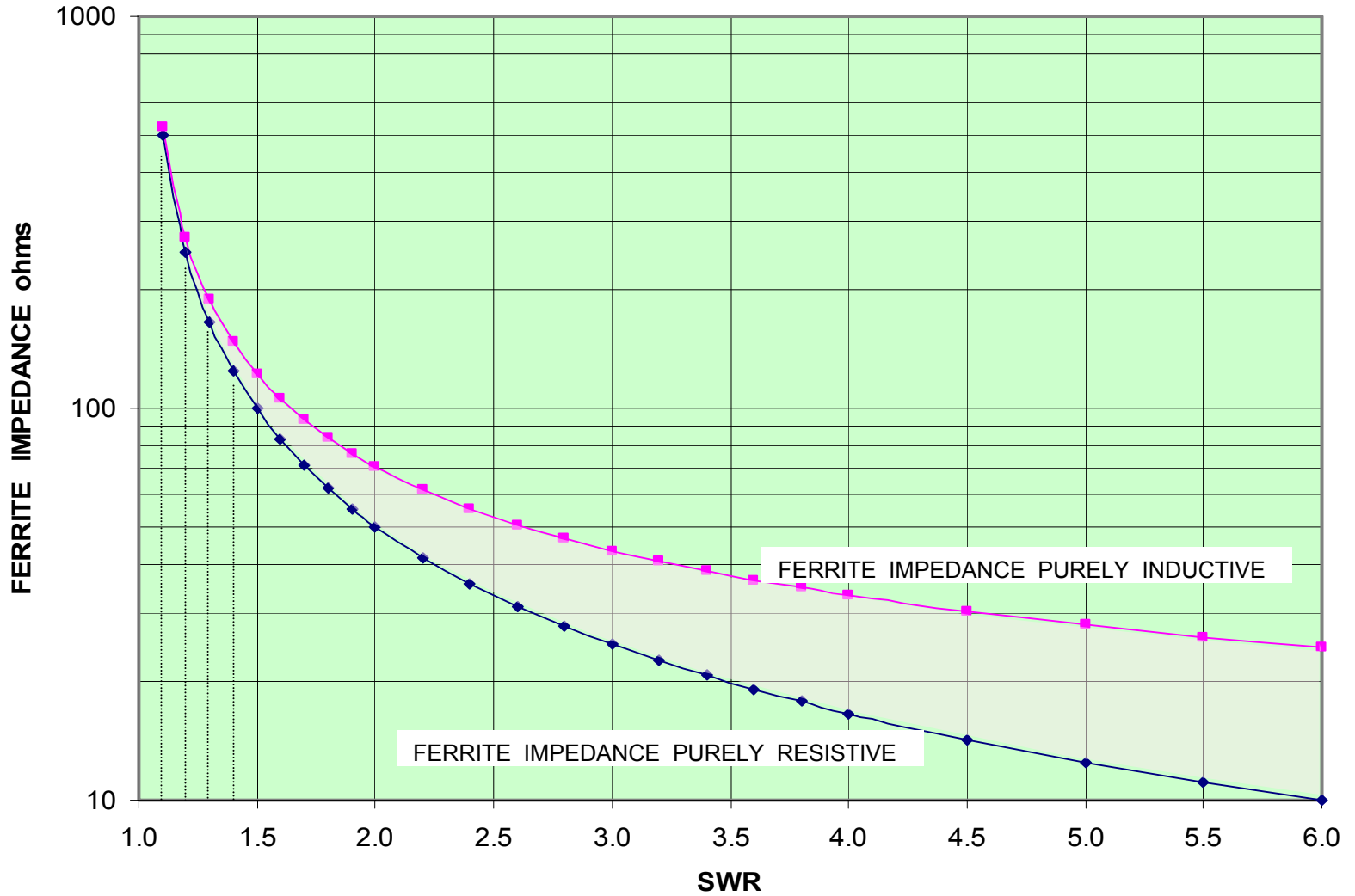

CURRENT BALUN GIVING A 4:1 IMPEDANCE RATIO

- USES 2 PARALLEL WIRES INSTEAD OF A COAX
- MAKES A COMPACT TRANSMISSION LINE

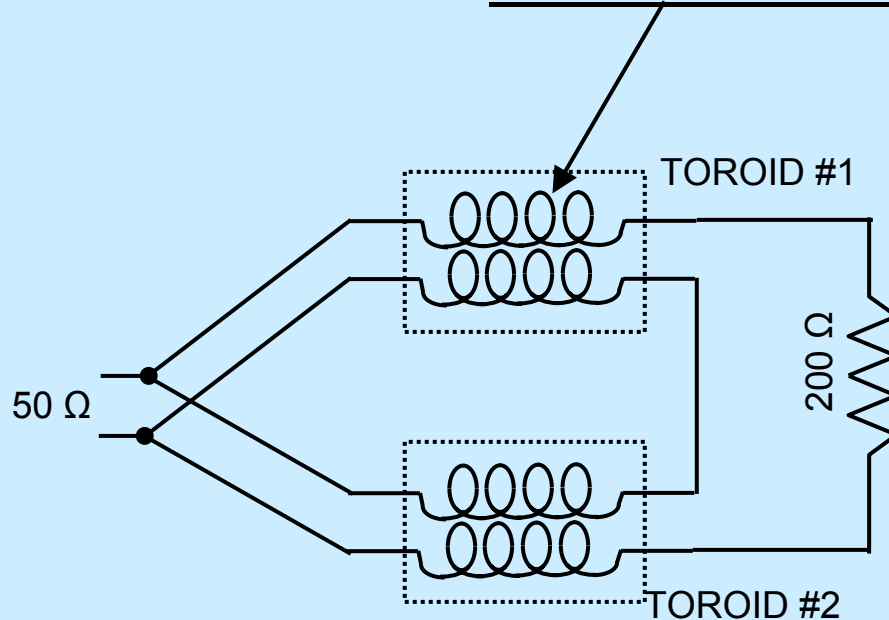

NOTE: THIS 4:1 CURRENT BALUN
IS SUPERIOR TO THE 4:1 VOLTAGE BALUN

CURRENT BALUN GIVING A 4:1 IMPEDANCE RATIO

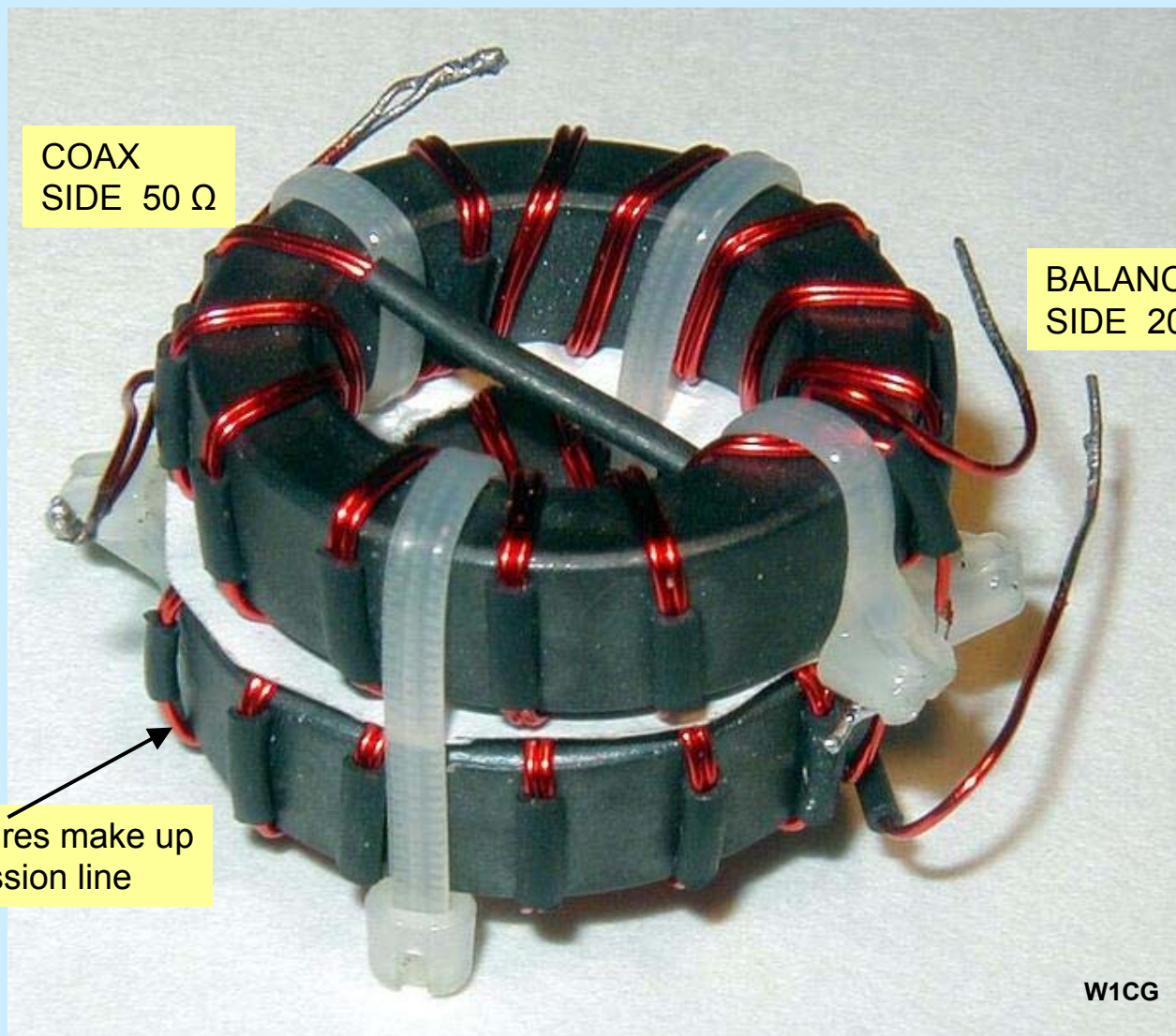

CURRENT MEASUREMENTS

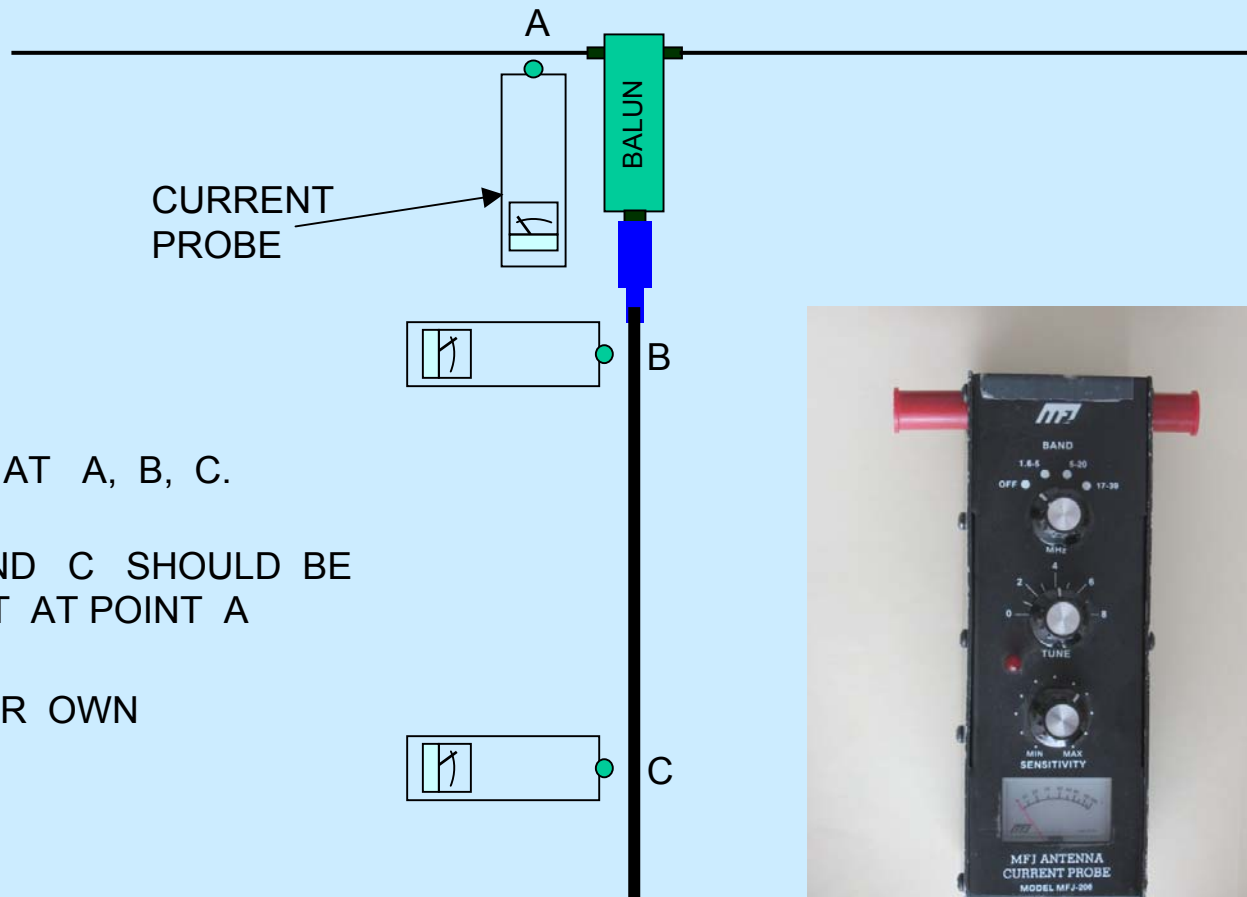

MEASURE CURRENT AT A, B, C.

CURRENTS AT B AND C SHOULD BE
< 10% THE CURRENT AT POINT A

YOU CAN MAKE YOUR OWN
CURRENT METER



MFJ-206

FERRITES MAY BE USED WITH A VOLTAGE BALUN

- MEASURE THE SHIELD CURRENT
- PUT THE FERRITES AT POINTS OF MAXIMUM CURRENT
- WILL FURTHER ISOLATE THE FEEDER FROM THE ANTENNA
- WILL STABILIZE THE ANTENNA IMPEDANCE
- MAY REDUCE THE NOISE PICK-UP BY THE FEEDER
- USE FERRITES AT EVERY QUARTER WAVELENGTH OR AT CURRENT MAXIMA

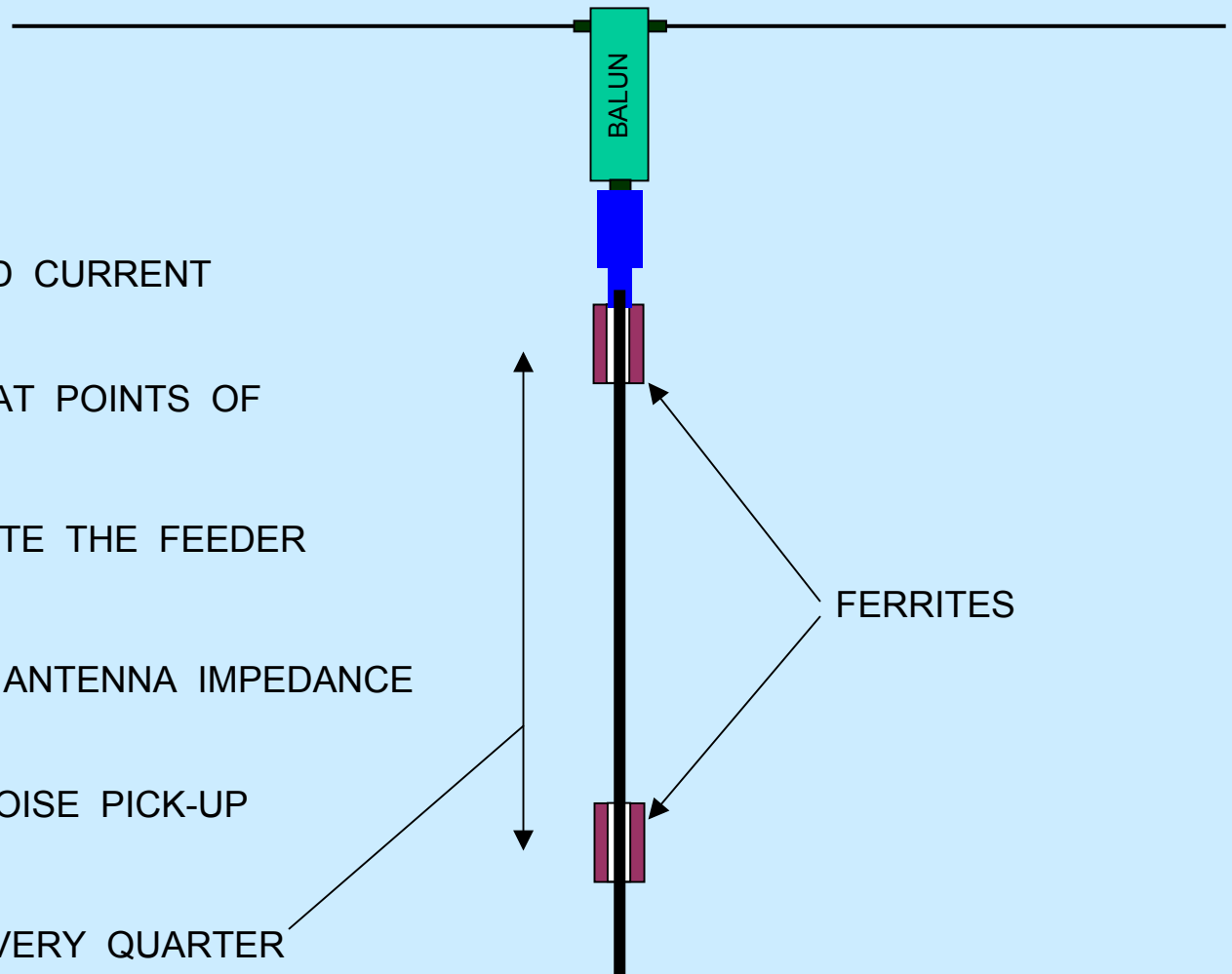

CURRENT BALUN MADE UP OF COAX CABLE

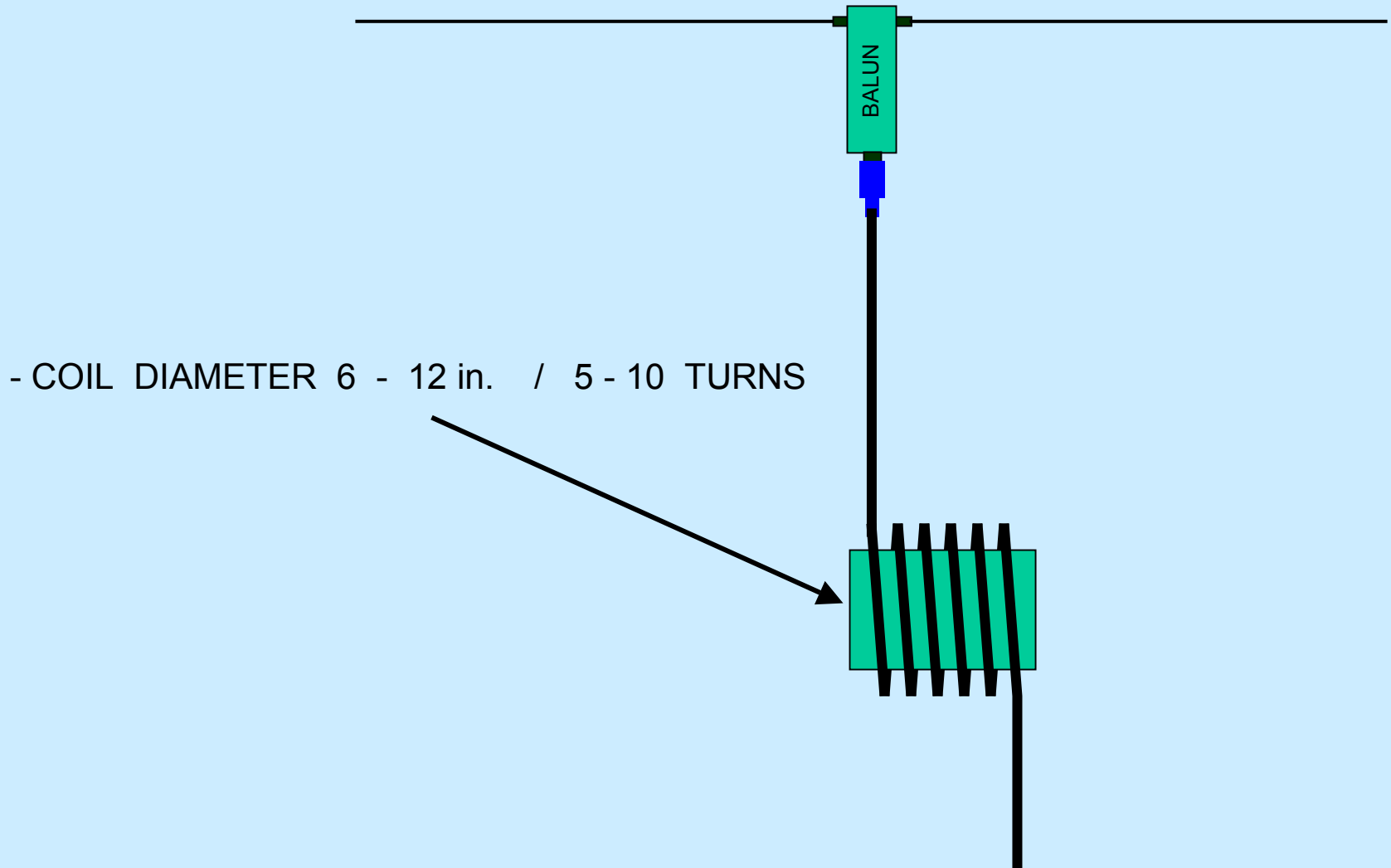

USING A BALUN ON A VERTICAL ANTENNA

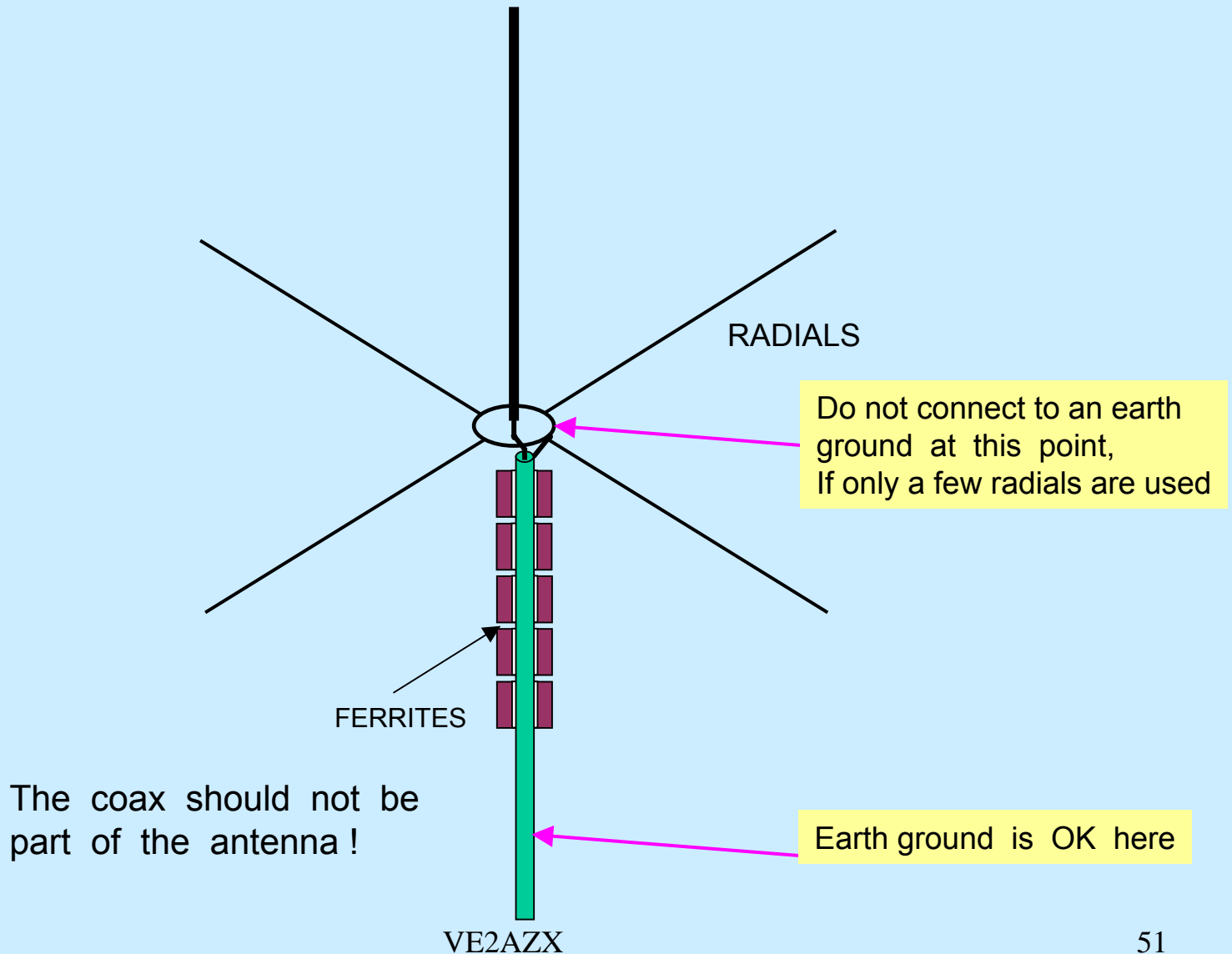

USING FERRITES ON THE FEEDER OF VERTICAL YAGI

PREVENT INTERACTION BETWEEN COAX + MAST WITH YAGI

Ref: QEX Sept – Oct. 2006

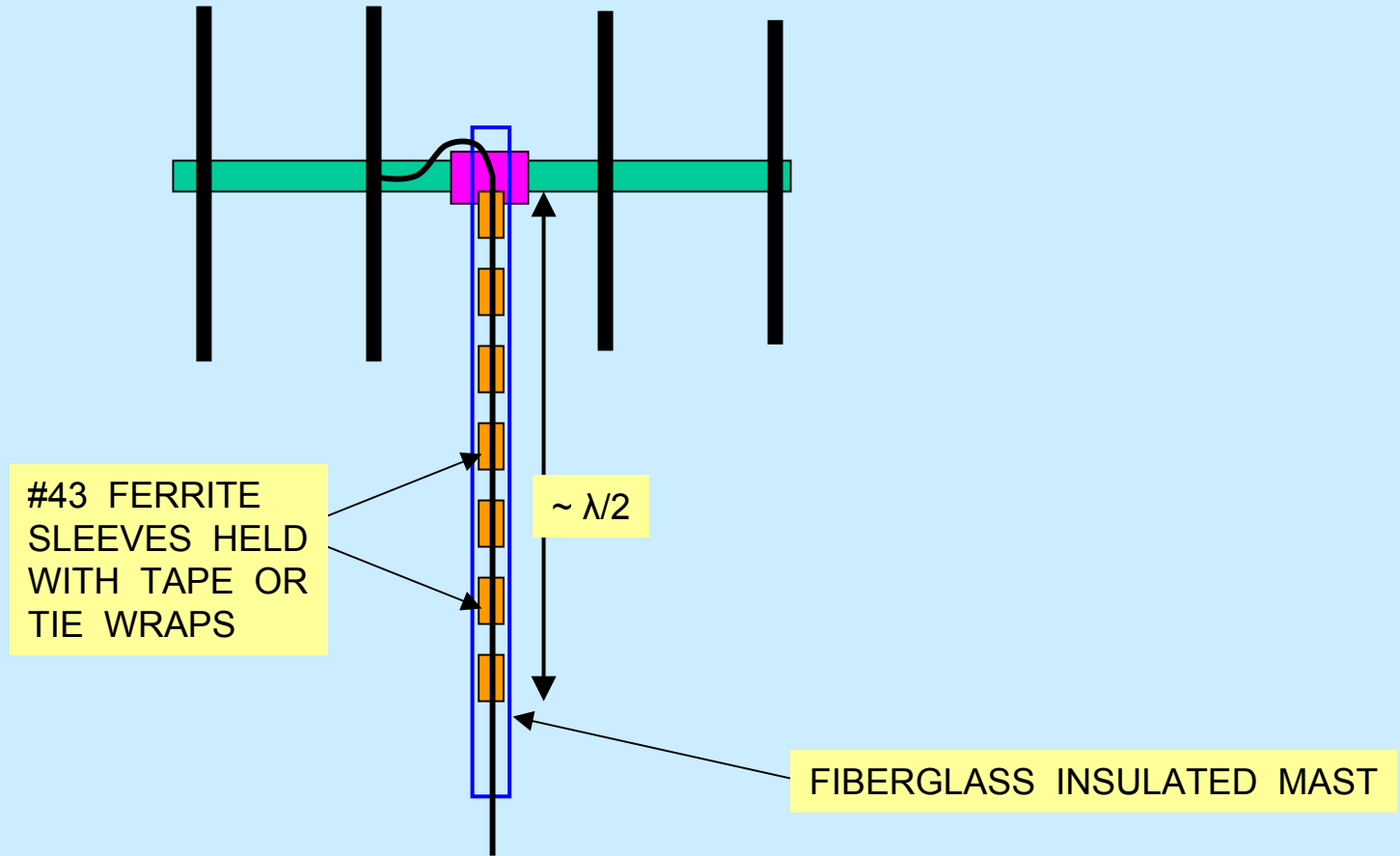

NOTES

- USING A BALUN UNDER HIGH SWR:

- VERIFY HEATING OF THE CORE
- DECREASE THE POWER
- USE MIX 73 ($\mu=2500$) OR 31 ($\mu=1500$)
FOR HIGH POWER USE MIX 43 ($\mu=850$) See Ref. 4
- BALUN LOSSES MAY / WILL INCREASE UNDER HIGH SWR
- VOLTAGE BALUN NOT RECOMMENDED IF SWR > 5:1 UNLESS
DESIGNED FOR HIGH SWR

- **BALUNS NORMALLY PROVIDE A VERY LOW ATTENUATION,
NORMALLY < 0.3 dB ... WHEN THE LOAD IS MATCHED**

FERRITES ARE USED EVERYWHERE

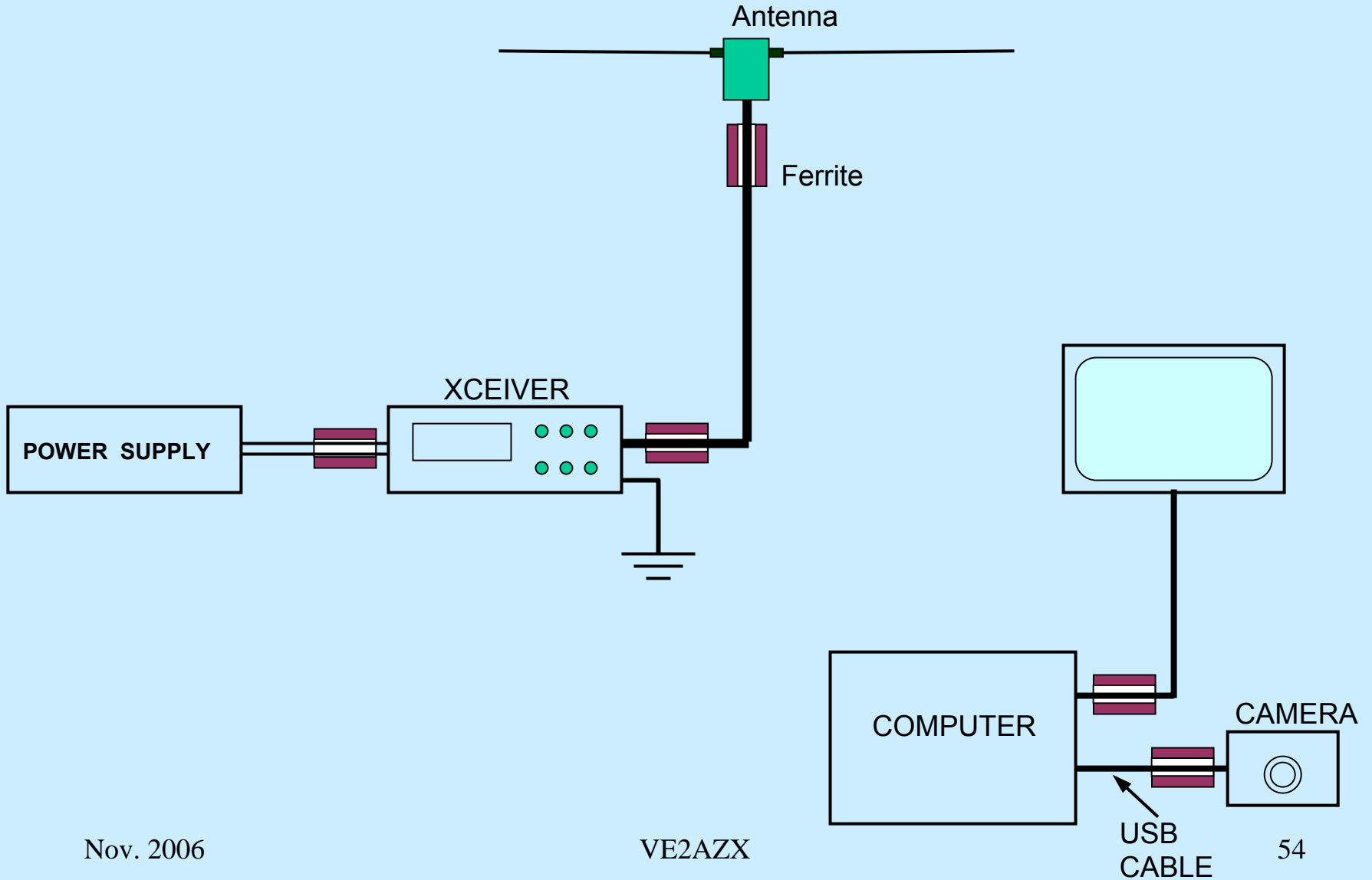

Nov. 2006

VE2AZX

THINGS TO REMEMBER...

- **VOLTAGE BALUNS** COVER A VERY WIDE RANGE OF IMPEDANCES
- SET EQUAL VOLTAGES AT THE OUTPUT
- GENERALLY PROVIDE NO PROTECTION AGAINST CURRENTS FLOWING ON COAX EXTERIOR
- MAY BE COMBINED WITH A CURRENT BALUN

- **CURRENT BALUNS** CREATE A AN IMPEDANCE ON THE OUTSIDE OF THE COAX (OR ANY CONDUCTOR)
- ALSO CALLED COMMON MODE CHOKES
- DECREASE COAX RADIATION AND PICK-UP
- STABILIZE THE ANTENNA IMPEDANCE
- GENERALLY 50:50 ohms RATIO (ALSO 50:200 POSSIBLE)

THINGS TO REMEMBER...

- DECREASE COAX RADIATION ON TRANSMIT
- AND PICK-UP ON RECEIVE

Extract from Ref. 4:

The most common reasons for using common-mode chokes are:

- (1) to reduce the fraction of the RF power that is fed to your antenna from your transmitter, but then is conducted back to your shack *via* common-mode current on your feedline, causing RFI trouble in the shack or elsewhere in your house;
- (2) to keep the transmitted RF power that 60-Hz power, telephone, TV, and other cables in the field of your antenna pick up, from bothering susceptible devices connected to these cables in your own and neighbors' houses

Extract from Ref. 4:

(3) to keep the RF noise that all the electronic devices in your house generate, from being conducted *via* 60-Hz power, telephone and other cables to the outer shield of your radio, and from there along your feedline(s) to your antenna(s), in common-mode.

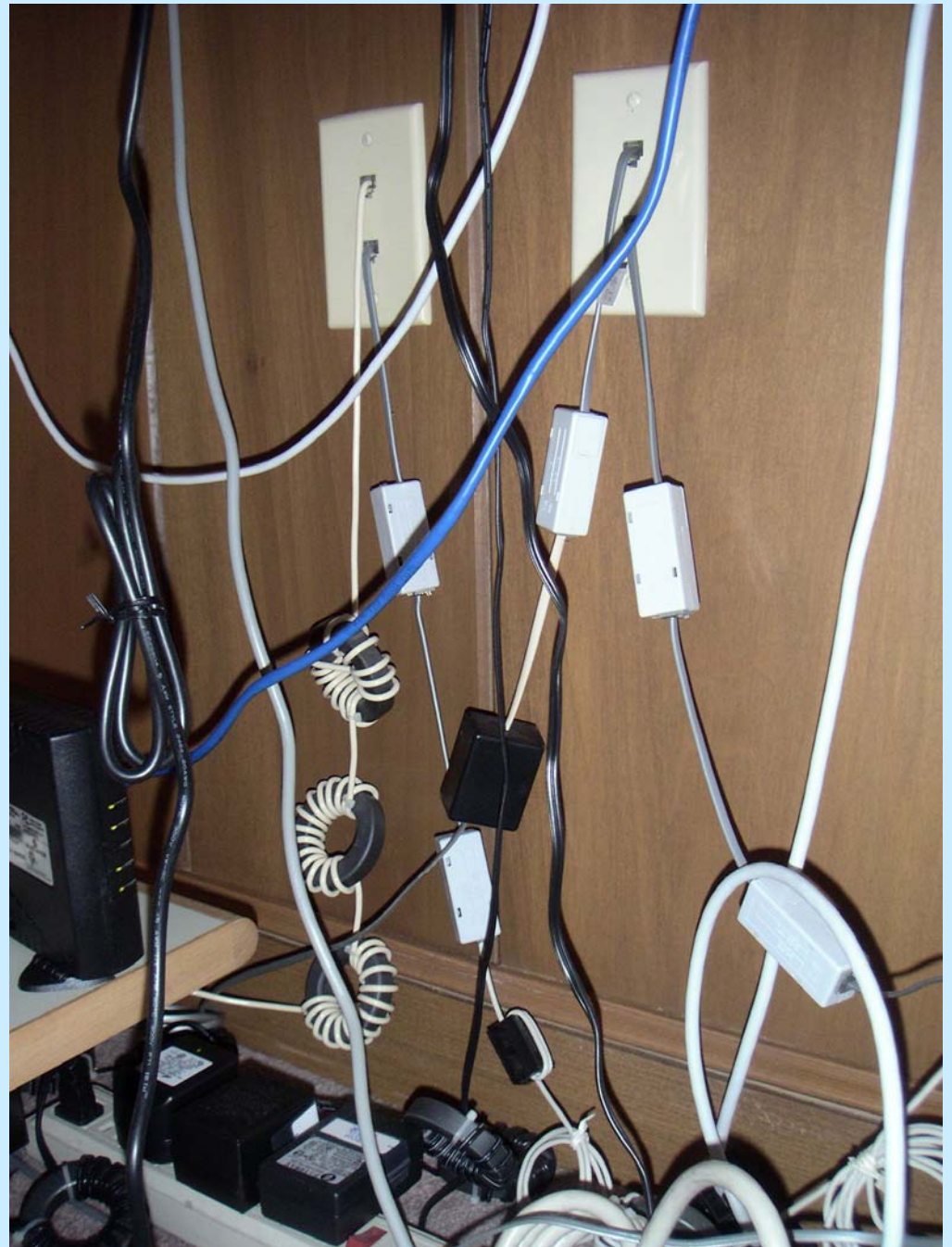

REFERENCES

1- **W1CG Low Power Balun Kit** <http://www.njqrp.org/balun/>

2- **Transmission Line Transformers, by Jerry Sevick W2FMI**

3- **VE2AZX Web Site (this presentation):** http://www.geocities.com/ve2_azx

4- **Chuck Counselman W1HIS :**

<http://www.yccc.org/Articles/W1HIS/CommonModeChokesW1HIS2006Apr06.pdf>

5- FERRITE SUPPLIERS

Digikey <http://www.digikey.com>

Fair-Rite <http://www.fair-rite.com>

Aimdon <http://www.amidoncorp.com>

ByteMark <http://www.cwsbytemark.com/prices/toroidal.php>